

Redwood II
2 Bedroom, 2 Bath - 1,026 SQ. FT.

Manufacturing West, Inc.
Albany Division - Plant #972
2445 S.W. PACIFIC BLVD.
ALBANY, OR 97321
Phone (541) 926-8631
Fax (866) 491-6847

SALES FLOOR PLAN

DRAWING TITLE

ORIGINAL DRAWING BY : G. LUND

SIDEWALL: 4" OR 6" **6" WALLS**

PRODUCT MODEL NO.
Inspiration **INS 382F**

SQ. FT. DATE
1,026 1-8-15

SHEET REVISED
1-A1 -

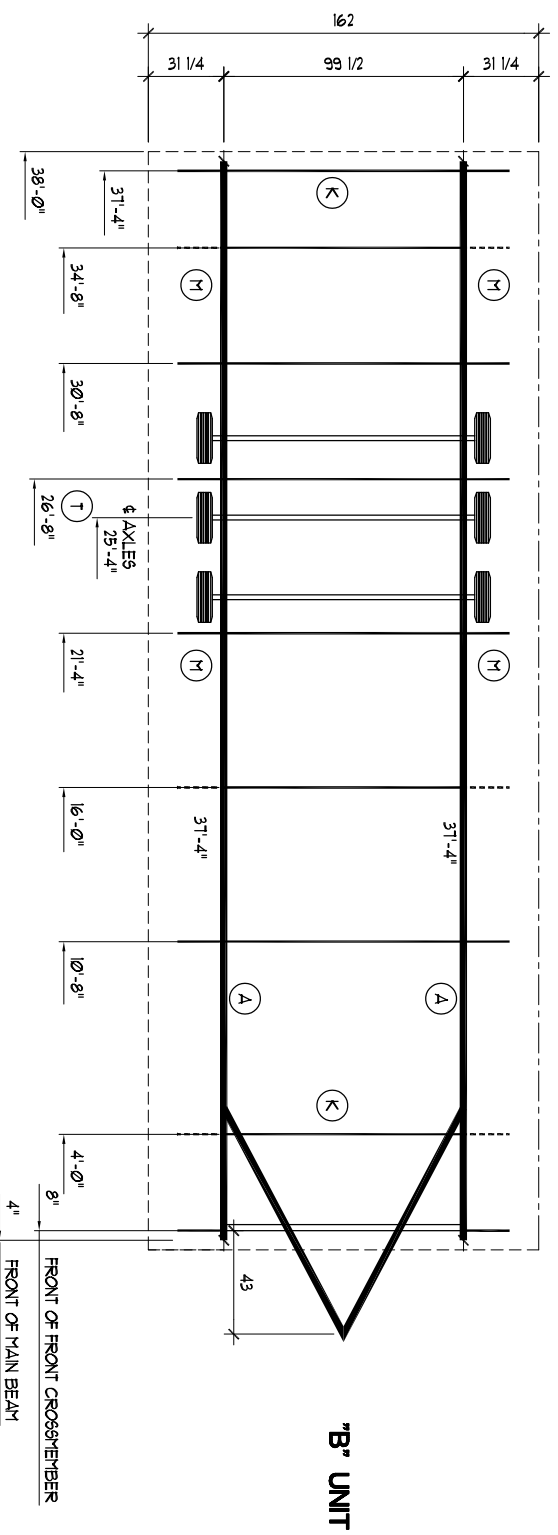
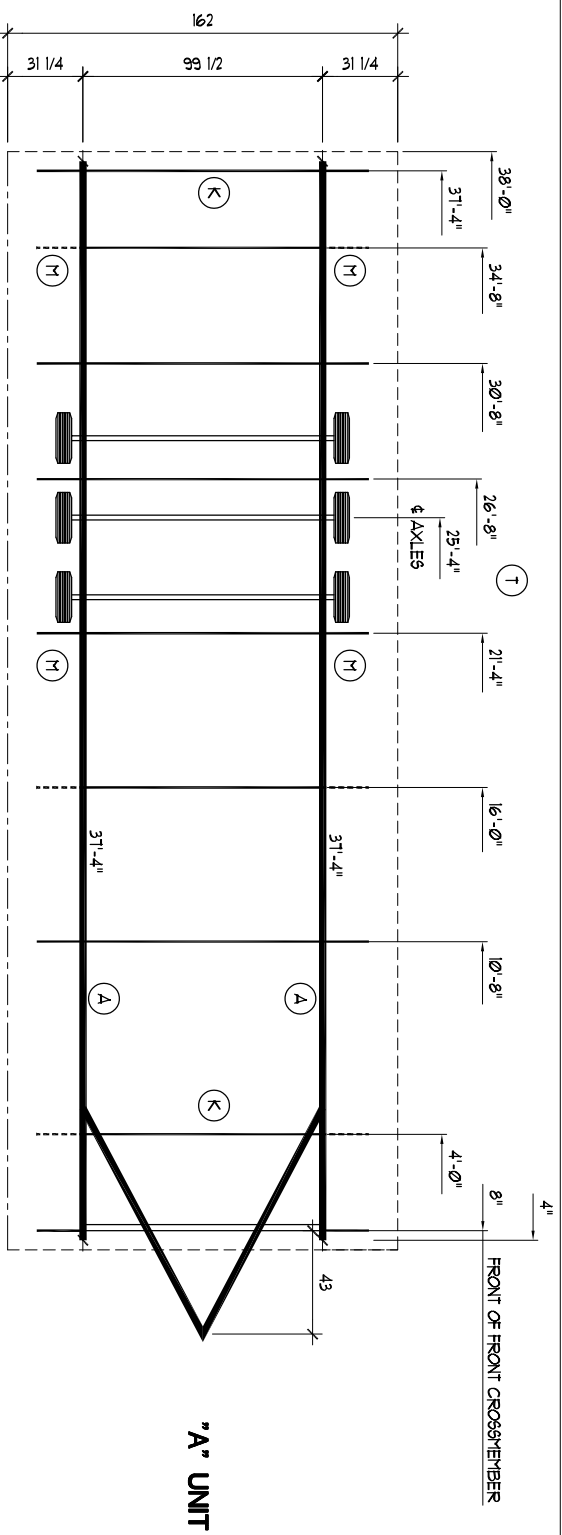

CHASSIS W/ PORCH ON 1-B5

TRANSVERSE CHASSIS
LEGEND

- A - MAIN BEAM - 8" X 6.5 B/H
- B - MAIN BEAM - 10" X 9.0 B/H
- C - MAIN BEAM - 12" X 10.8 B/H
- D - MAIN BEAM - 12 1/2" X 12.4 B/H
- E - FRONT CROSSMEMBER - 2 GA. - 2 8 1/4" X 100" (H:-10°-13°-5' WIDE)
- F - FRONT CROSSMEMBER - 2 GA. - 2 8 1/4" X 100" (H:-10°-13°-5' WIDE)
- G - FRONT CROSSMEMBER - 2 GA. - 2 10 1/4" X 100" (H:-10°-13°-5' WIDE)
- H - FRONT CROSSMEMBER - 2 GA. - 2 10 1/4" X 100" (H:-10°-13°-5' WIDE)
- I - FRONT CROSSMEMBER - 2 GA. - 2 12 1/4" X 100" (H:-10°-13°-5' WIDE)
- J - FRONT CROSSMEMBER - 2 GA. - 2 12 1/4" X 100" (H:-10°-13°-5' WIDE)
- K - CROSSMEMBER - 1/8" - ANGLE 2" X 2" X 99 3/8"
- L - OUTRIGGER - 13 GA. - 1 1/2" X 12" (H:-10° WIDE KARSTEN)
- M - OUTRIGGER - 13 GA. - 1 1/2" X 12" (H:-10° WIDE)
- N - OUTRIGGER - 13 GA. - 1 1/2" X 12" (H:-10° WIDE KARSTEN)
- O - OUTRIGGER - 13 GA. - 1 1/2" X 12" (H:-10° WIDE)
- P - OUTRIGGER - 13 GA. - 1 1/2" X 12" (H:-10° WIDE)
- Q - OUTRIGGER - 13 GA. - 1 1/2" X 12" (H:-10° WIDE)
- R - UNDER CARRIAGE ASSY. - TANDEM AXLE - 1 BRAKING
- S - UNDER CARRIAGE ASSY. - TANDEM AXLE - 2 BRAKING
- T - UNDER CARRIAGE ASSY. - TRIPLE AXLE - 2 BRAKING (I) DLEH
- U - UNDER CARRIAGE ASSY. - QUAD AXLE - 2 BRAKING (I) DLEH
- V - UNDER CARRIAGE ASSY. - QUAD AXLE - 2 BRAKING (I) DLEH
- W - UNDER CARRIAGE ASSY. - SEXTPL AXLE - 2 BRAKING (I) DLEH
- X - MATING ANGLE - DETAIL PER STRUCT. DWG. 92.00 "C"
- Y - A/R RETURN CROSSOVER MEMBER - 1/8" X 2" X 2" STEEL ANGLE

NOTES:

1. CHASSIS AND HITCH DETAILS PER STRUCT. DWG. 92.00
2. FLOOR OVERHANG DETAIL PER STRUCT. DWG. 93.02-B
3. GW HITCH PER 92.06 / KARSTEN HITCH PER 208.20

NOTE: TRIPLE WIDE CENTER SECTIONS AND 4:12 30 WIDES MUST HAVE UNDER-SLUNG AXLES AND EQUALIZERS

ALL HOUSES WITH 12" BEAM MUST HAVE UNDER-SLUNG AXLES.

HOUSES WITH 9" SIDEWALLS AND 2X8 FLOOR JOISTS WITH 10" BEAM AND EQUALIZERS MUST HAVE UNDER-SLUNG AXLES.

Manufacturing West, Inc.
Albany Division - Plant #972
2445 S.W. PACIFIC BLVD.
ALBANY, OR 97321
Phone (541) 926-8631
Fax (866) 491-6847

DRAWING TITLE
CHASSIS PLAN

ORIGINAL DRAWING BY : -

SIDEWALL: 4" OR 6" **6" WALLS**

PRODUCT MODEL NO.
Inspiration **INS 382F**

SQ. FT. DATE
1,026 1-8-15

SHEET REVISED
1-45 07-13-15

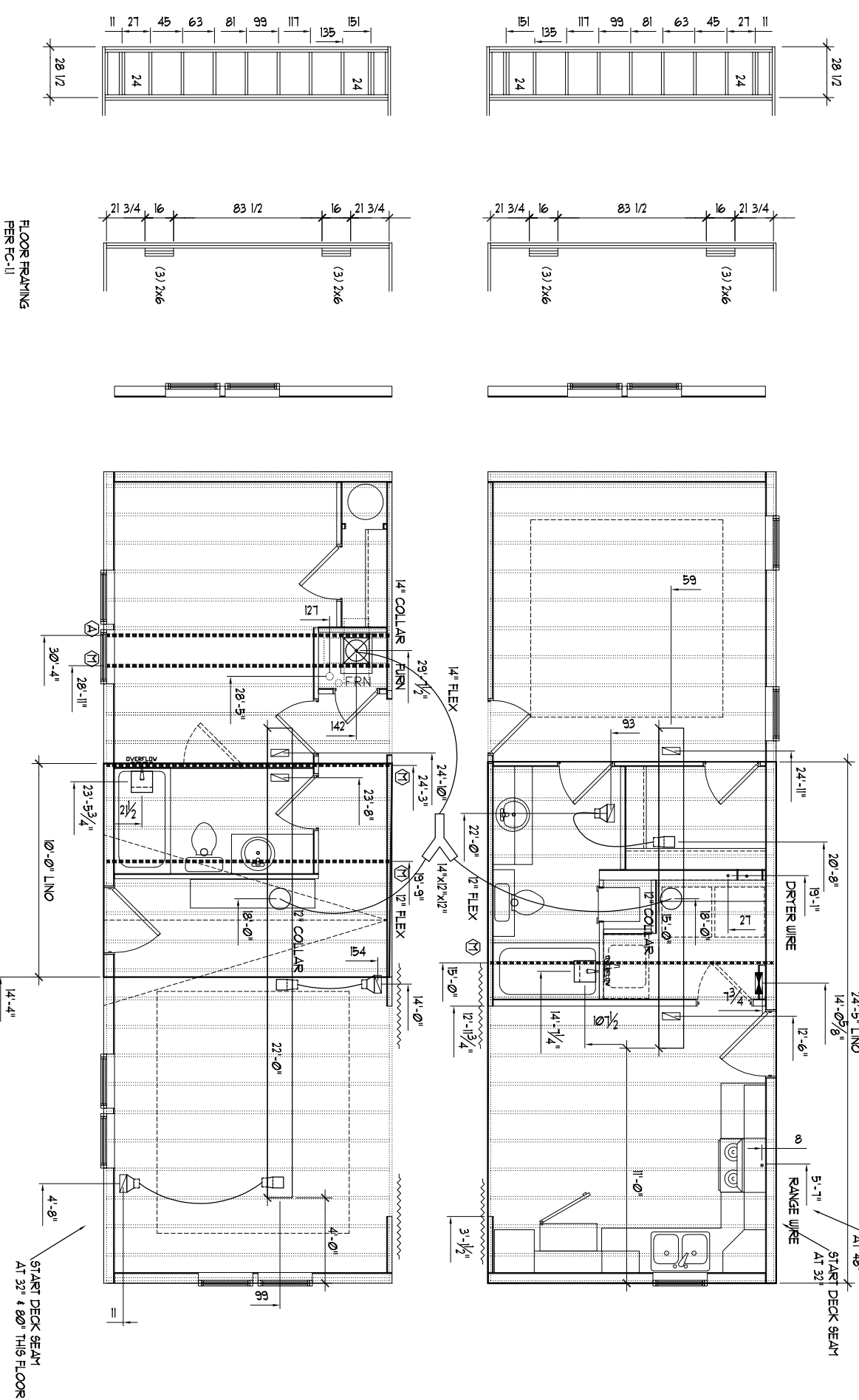

- NOTES:
- (M) MOVE JOIST (A) ADD JOIST (M) MULTIPLE JOISTS
 - (C) BLOCK PER FC-010 A (E) BLOCK PER FC-011 E
 - ~~~~~ EXTRA RIM NAILS & LAGS AT POSTS (FC-016 B/C)

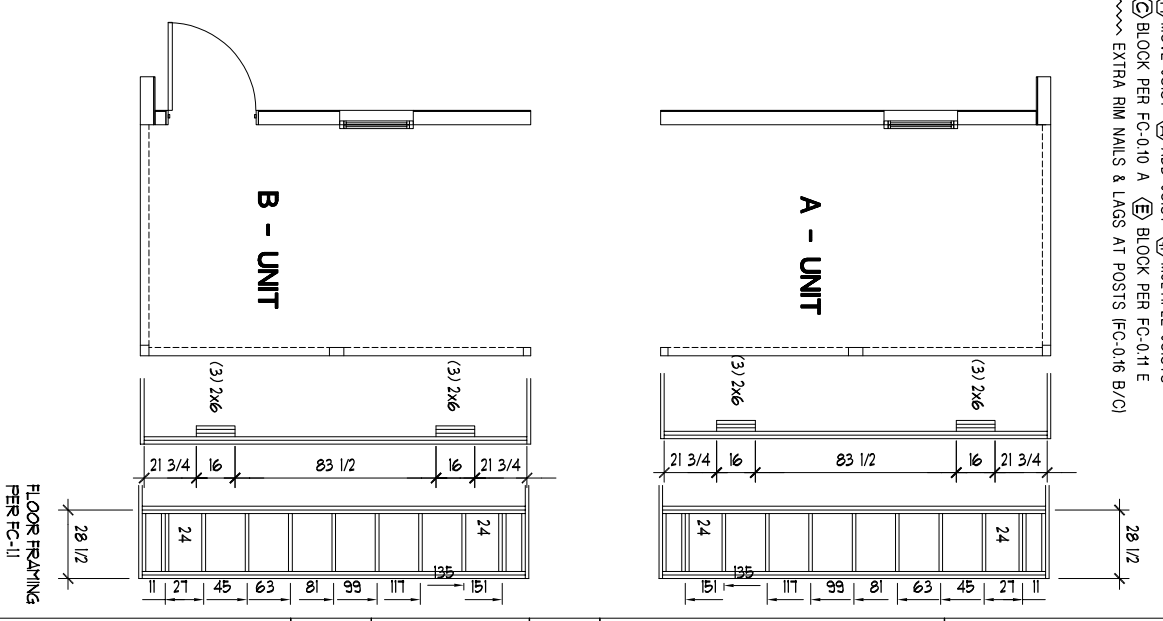

OPT. FLEX INFO

WYES

14" x 12" x 12"

STD. FLEX DUCT

14" FLEX

10'-0"

12" FLEX

25'-0"

8" FLEX

6" FLEX

0' = 0"

Manufacturing West, Inc.
 Albany Division - Plant #972
 2445 S.W. PACIFIC BLVD.
 ALBANY, OR 97321
 Phone (541) 926-8631
 Fax (866) 491-6847

DRAWING TITLE
FLOOR & HEAT DUCT

ORIGINAL DRAWING BY :
6" WALLS

SIDEWALL: 4" OR 6"
 PRODUCT MODEL NO.
 Inspiration **INS 382F**

SQ. FT. 1,026
 DATE 1-8-15
 SHEET 1-A6
 REVISED 5-9-19

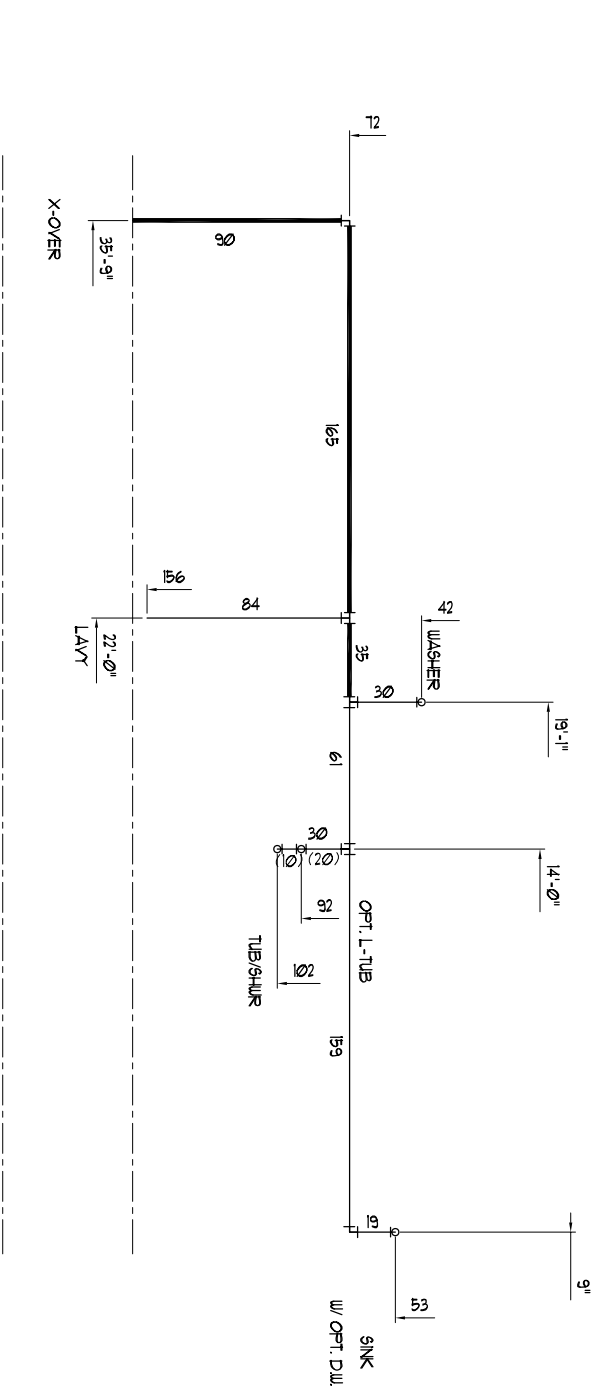

A - UNIT

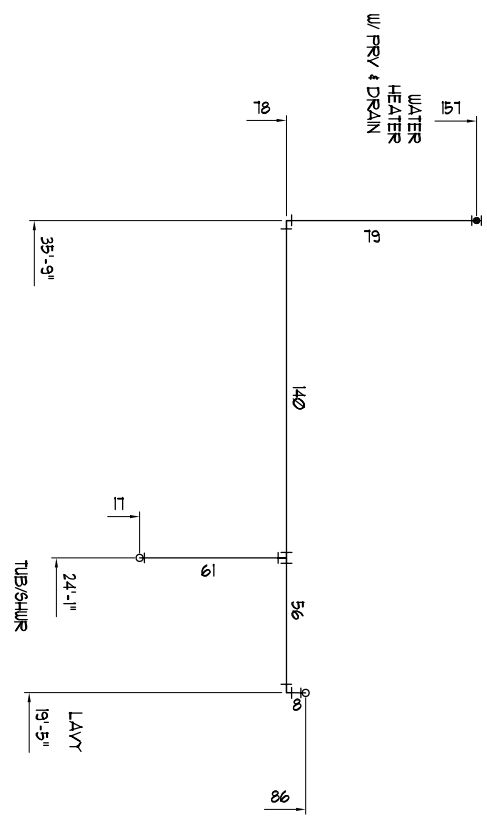

B - UNIT

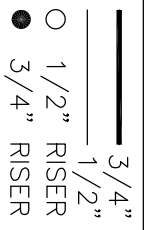

PIPE DIMS ARE TO CENTER OF FITTING. ADJUST LENGTH PER FITTING.

Manufacturing West, Inc.
 Albany Division - Plant #972
 2445 S.W. PACIFIC BLVD.
 ALBANY, OR 97321
 Phone (541) 926-8631
 Fax (866) 491-6847

HOT WATER LINES

DRAWING TITLE
 ORIGINAL DRAWING BY :
 SIDEWALL: 4" OR 6"
6" WALLS

PRODUCT	Inspiration	MODEL NO.	INS 382F
SQ. FT.	1,026	DATE	1-8-15
SHEET	1-48	REVISED	5-7-18 GL

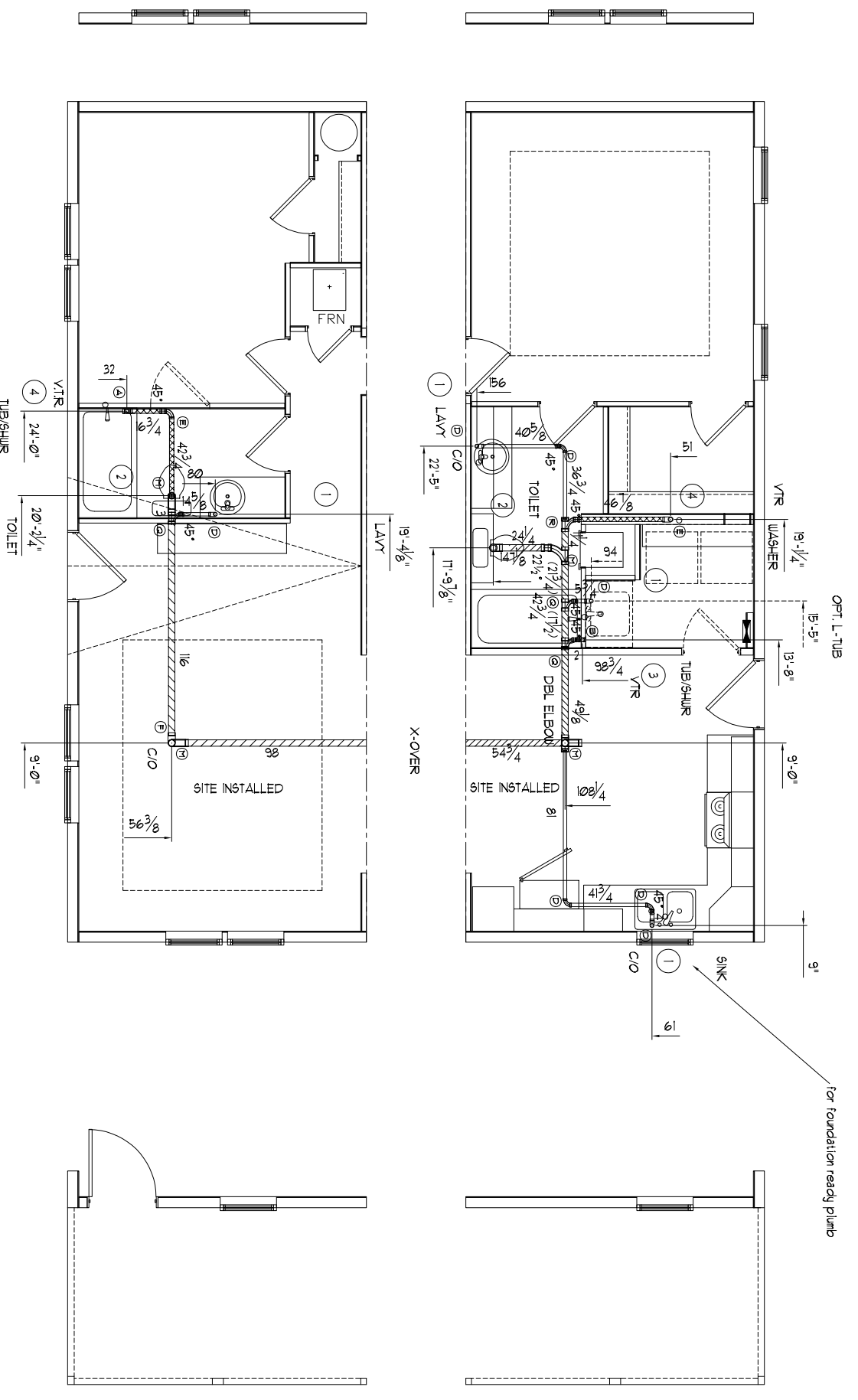

TRANSVERSE PIPE LEGEND
 1 1/2" PIPE
 2" PIPE
 3" PIPE

LEGEND

ELEVATIONS OF TYPICAL ASSEMBLIES
 1) TRAP ARM CAN BE ROTATED
 2) FITTINGS AT BASE OF VERTICAL PIPE TO BE SHOWN ON PLAN

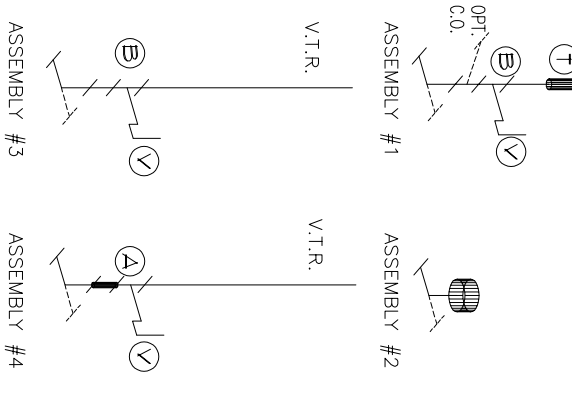

SYMBOL	DESCRIPTION
A	2"x1 1/2"x1 1/2" SAN TEE
B	1 1/2"x1 1/2" SAN TEE
C	3"x3"x2" SAN TEE
D	1 1/2"x2" 90° XLT ELBOW
E	2" 90° XLT ELBOW
F	3" 90° XLT ELBOW
G	1 1/2"x3" 45° XLT ELBOW
H	1 1/2"x3" PIPE INCREASER
J	2"x3" PIPE INCREASER
K	1 1/2" LTTY SINGLE
L	2" LTTY SINGLE
M	3" LTTY SINGLE
N	2"x1 1/2"x1/2" LTTY SINGLE
P	2"x2"x1 1/2" LTTY SINGLE
Q	3"x3"x1 1/2" LTTY SINGLE
R	3"x3"x2" LTTY SINGLE
S	2"x3"x2" LTTY SINGLE
T	MECHANICAL VENT
U	2"x1 1/2"x1 1/2" DBL. FIX. FTG.
V	1 1/2" P-TRAP CLEANOUT COUPLER
W	CONTINUOUS FITTING

Manufacturing West, Inc.
 Albany Division - Plant #972
 2445 S.W. PACIFIC BLVD.
 ALBANY, OR 97321
 Phone (541) 926-8631
 Fax (866) 491-6847

WASTE LINES PLAN

ORIGINAL DRAWING BY :
 SIDEWALL: 4" OR 6" **6" WALLS**

PRODUCT Inspiration
 MODEL NO. **INS 382F**

SQ. FT. 1,026
 DATE 1-8-15

SHEET **1-A9**
 REVISED 5-7-18 GL

TRANSVERSE PIPE LEGEND
 1 1/2" PIPE
 2" PIPE
 3" PIPE

LEGEND

ELEVATIONS OF TYPICAL ASSEMBLIES
 1) TRAP ARM CAN BE ROTATED
 2) FITTINGS AT BASE OF VERTICAL PIPE TO BE SHOWN ON PLAN

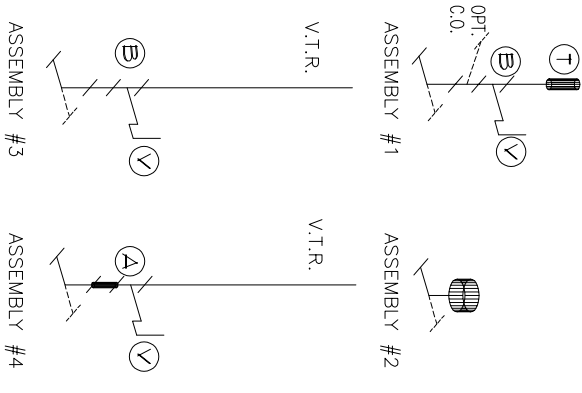

A - UNIT

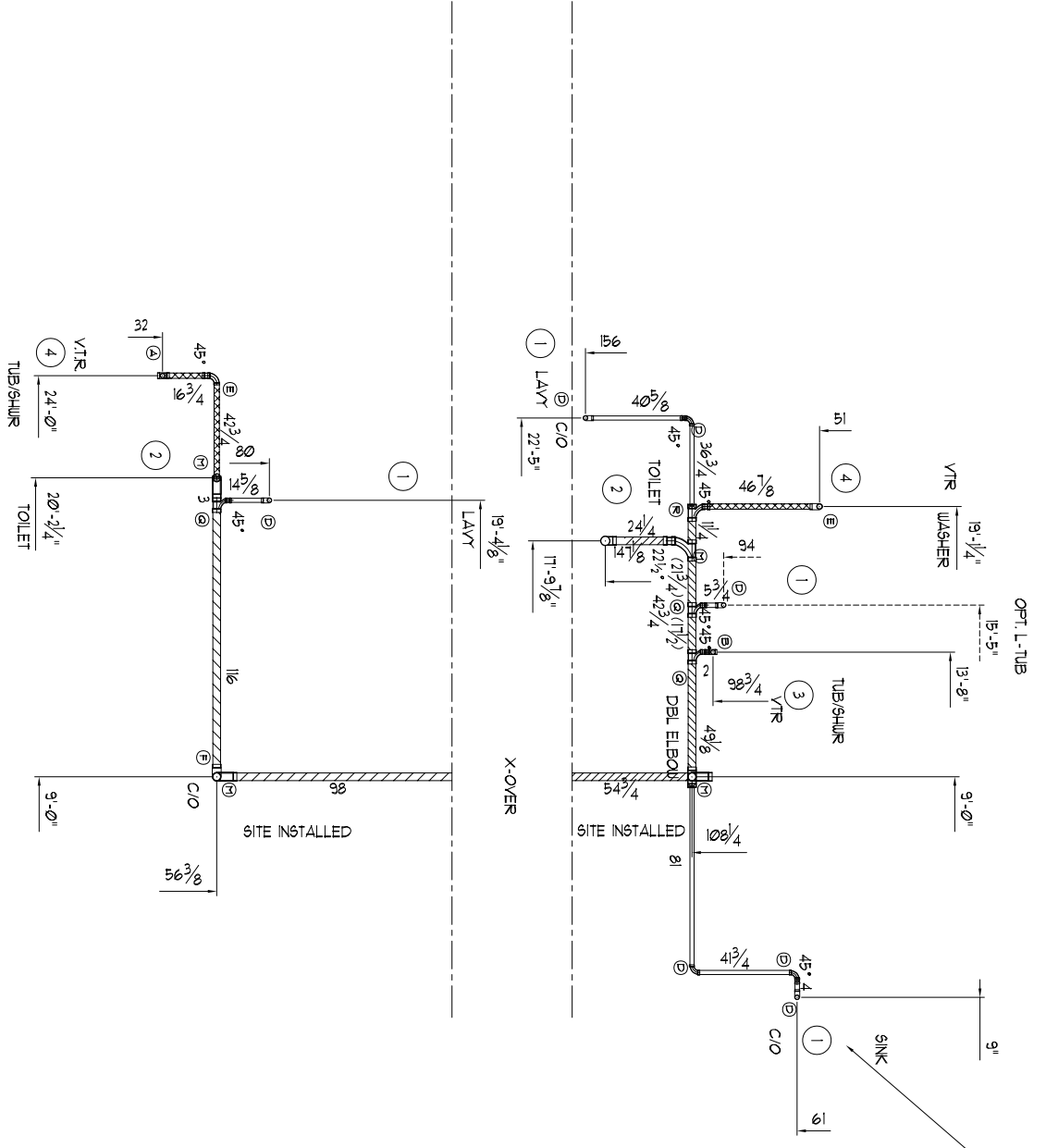

B - UNIT

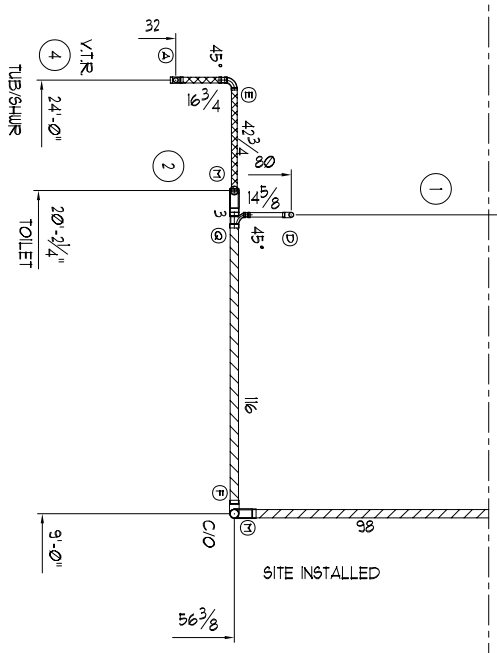

SYMBOL	DESCRIPTION
A	2"x1 1/2"x1 1/2" SAN TEE
B	1 1/2"x1 1/2" SAN TEE
C	3"x3"x2" SAN TEE
D	1 1/2"x2" 90° XLT ELBOW
E	2" 90° XLT ELBOW
F	3" 90° XLT ELBOW
G	1 1/2"x2" 45° XLT ELBOW
H	1 1/2"x3" PIPE INCREASER
J	2"x3" PIPE INCREASER
K	1 1/2" LTTY SINGLE
L	2" LTTY SINGLE
M	3" LTTY SINGLE
N	2"x1 1/2"x2" LTTY SINGLE
O	2"x2"x1 1/2" LTTY SINGLE
P	3"x3"x1 1/2" LTTY SINGLE
Q	3"x3"x2" LTTY SINGLE
R	2"x3"x2" LTTY SINGLE
S	2"x3"x2" LTTY SINGLE
T	MECHANICAL VENT
U	2"x1 1/2"x2" LTTY SINGLE
V	1 1/2" F-TRAP CLEANOUT COUPLER
W	CONTINUOUS FITTING

Manufacturing West, Inc.
 Albany Division - Plant #972
 2445 S.W. PACIFIC BLVD.
 ALBANY, OR 97321
 Phone (541) 926-8631
 Fax (866) 491-6847

WASTE LINES PLAN

ORIGINAL DRAWING BY :
 SIDEWALL: 4" OR 6" **6" WALLS**

PRODUCT	Inspiration	MODEL NO.	INS 382F
SQ. FT.	1,026	DATE	1-8-15
SHEET	1-A9	REVISED	5-7-18 GL

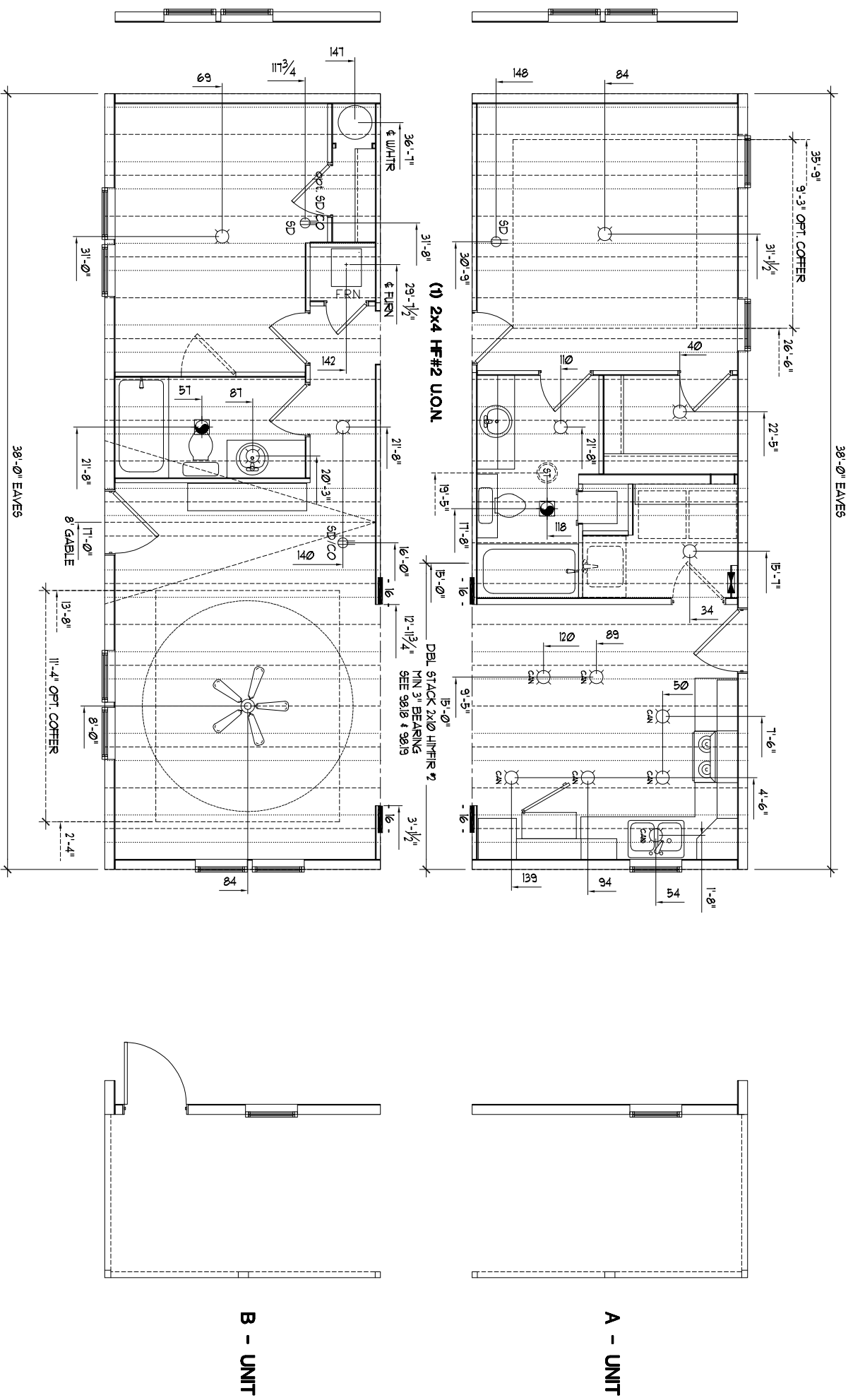

A - UNIT

B - UNIT

Manufacturing West, Inc.
 Albany Division - Plant #972
 2445 S.W. PACIFIC BLVD.
 ALBANY, OR 97321
 Phone (541) 926-8631
 Fax (866) 491-6847

DRAWING TITLE
ROOF/CEILING DETAILS

ORIGINAL DRAWING BY :
 SIDEWALL: 4" OR 6"
6" WALLS

PRODUCT	Inspiration	MODEL NO.	INS 382F
SQ. FT.	1,026	DATE	1-8-15
SHEET	1-A11	REVISED	7-30-20

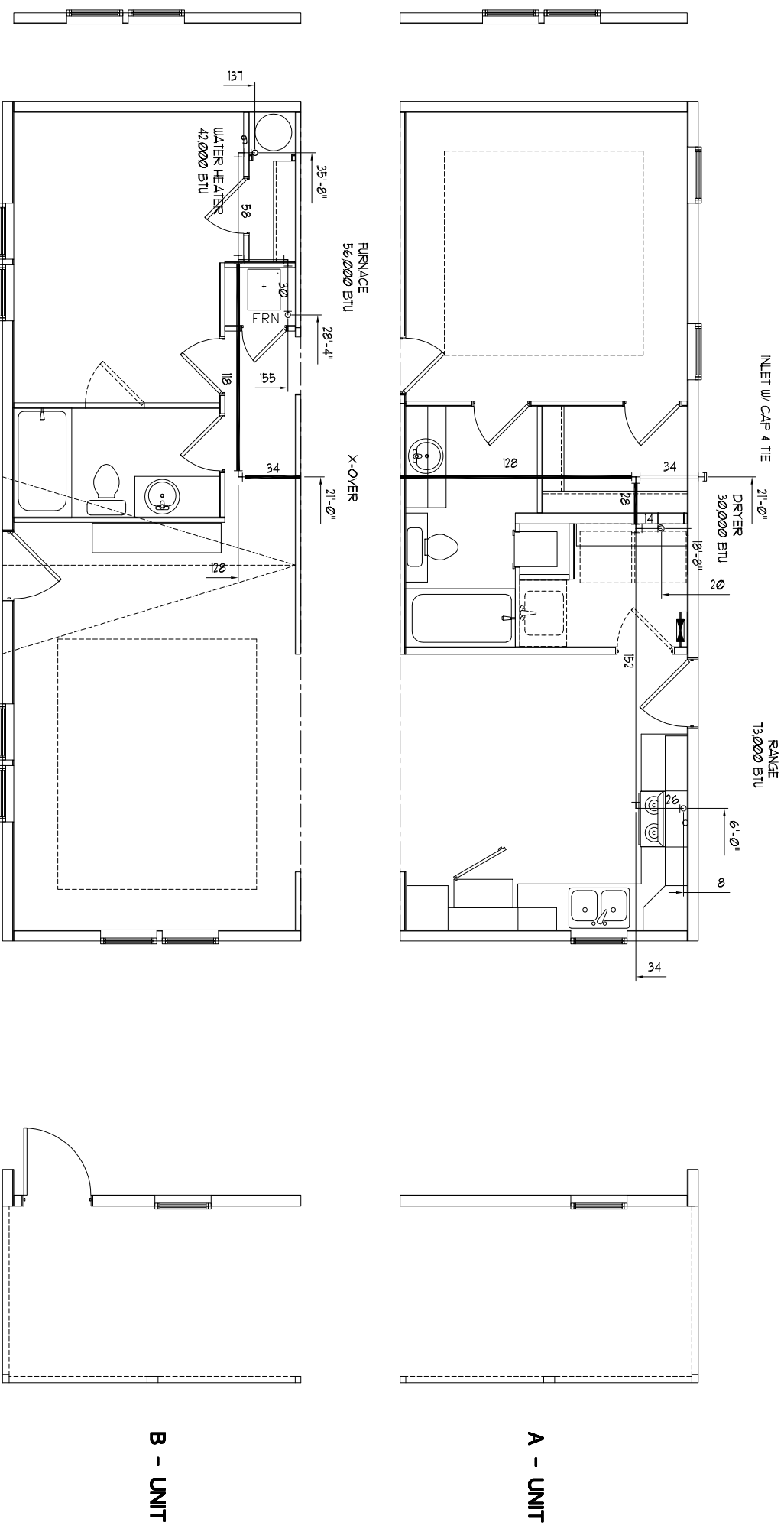

RUN = 40'-0" MAX. BTU = 201,000

<p>3/4" MIN. INLET REQ'D</p> <p>PIPE LEGEND</p> <p>1" ——— 3/4"</p> <p>1/2" ——— 1/2"</p> <p>○ 1/2" RISER</p> <p>● 3/4" RISER</p>	
<p>Manufacturing West, Inc.</p> <p>Albany Division - Plant #972</p> <p>2445 S.W. PACIFIC BLVD.</p> <p>ALBANY, OR 97321</p> <p>Phone (541) 926-8631</p> <p>Fax (866) 491-6847</p>	
<p>DRAWING TITLE</p> <p>GAS LINES PLAN</p>	
<p>ORIGINAL DRAWING BY : -</p>	
<p>SIDEWALL: 4" OR 6" 6" WALLS</p>	
<p>PRODUCT</p> <p>Inspiration</p>	<p>MODEL NO.</p> <p>INS 382F</p>
<p>SQ. FT.</p> <p>1,026</p>	<p>DATE</p> <p>1-8-15</p>
<p>SHEET</p> <p>1-A10</p>	<p>REVISED</p> <p>1-20-20</p>

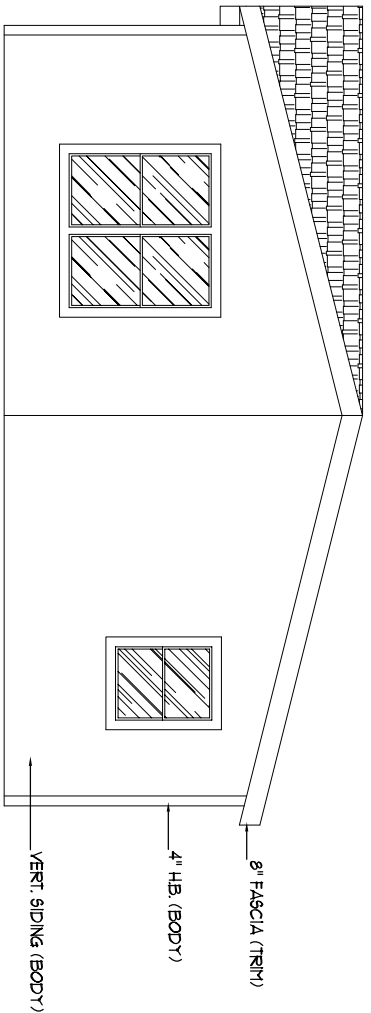

ENDWALL ELEVATION

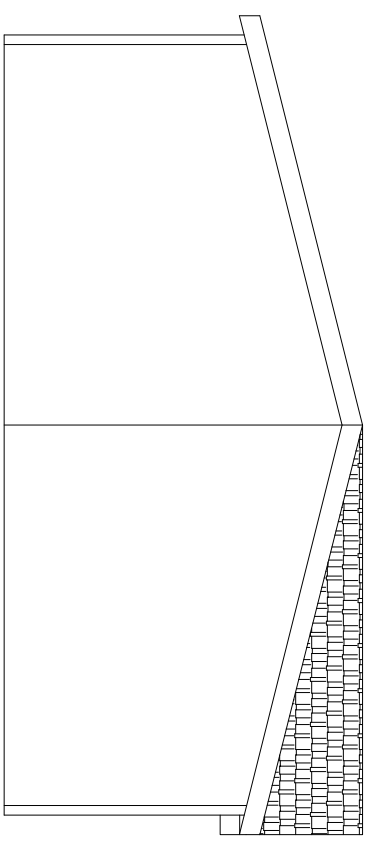

ENDWALL ELEVATION

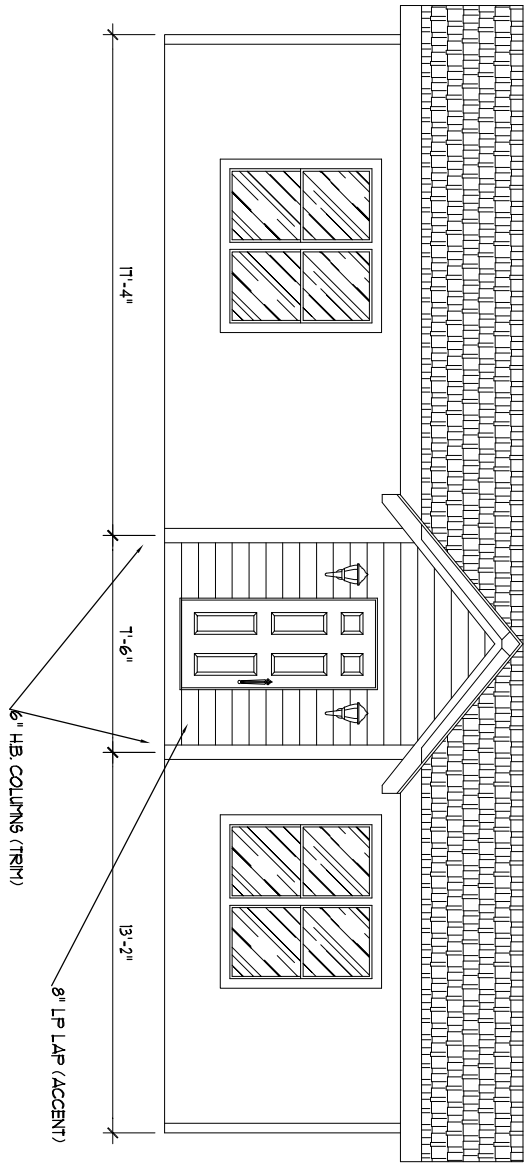

SIDEWALL ELEVATION

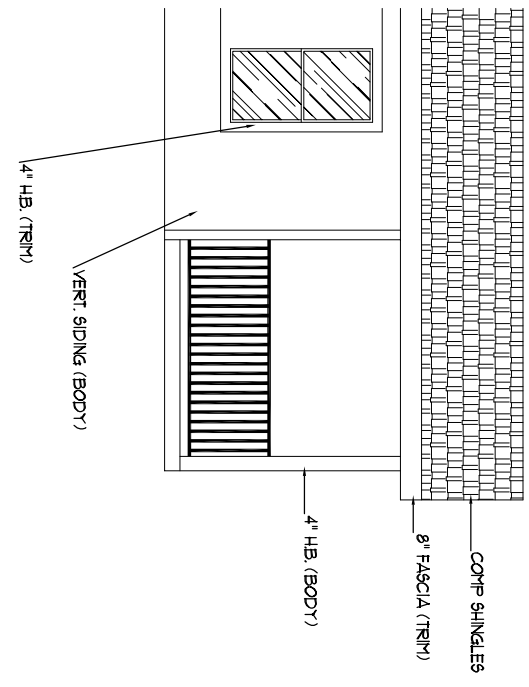

OPT. PORCH

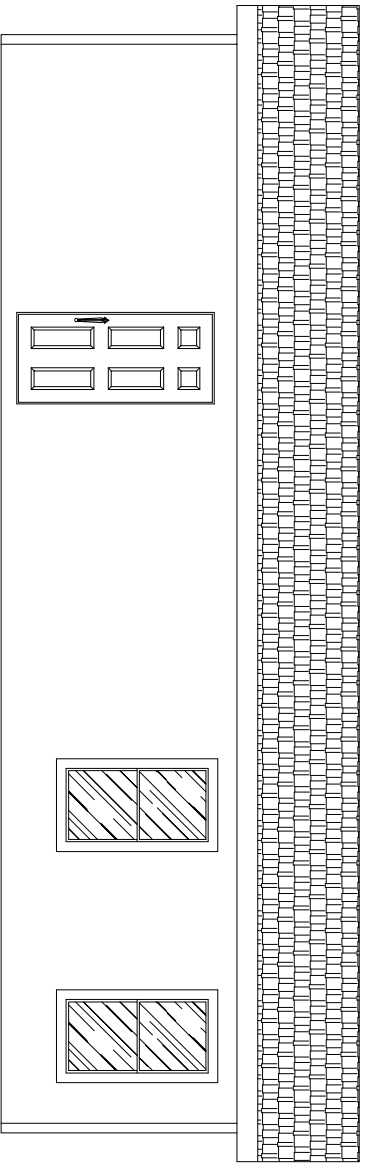

SIDEWALL ELEVATION

Manufacturing West, Inc.
 Albany Division - Plant #972
 2445 S.W. PACIFIC BLVD.
 ALBANY, OR 97321
 Phone (541) 926-8631
 Fax (866) 491-6847

DRAWING TITLE
EXTERIOR ELEVATION

ORIGINAL DRAWING BY : G. LUND

SIDEWALL: 4" OR 6" **6" WALLS**

PRODUCT	Inspiration	MODEL NO.	INS 382F
SQ. FT.	1,026	DATE	1-8-15
SHEET	2-4	REVISED	-

UPGRADE OH CABS

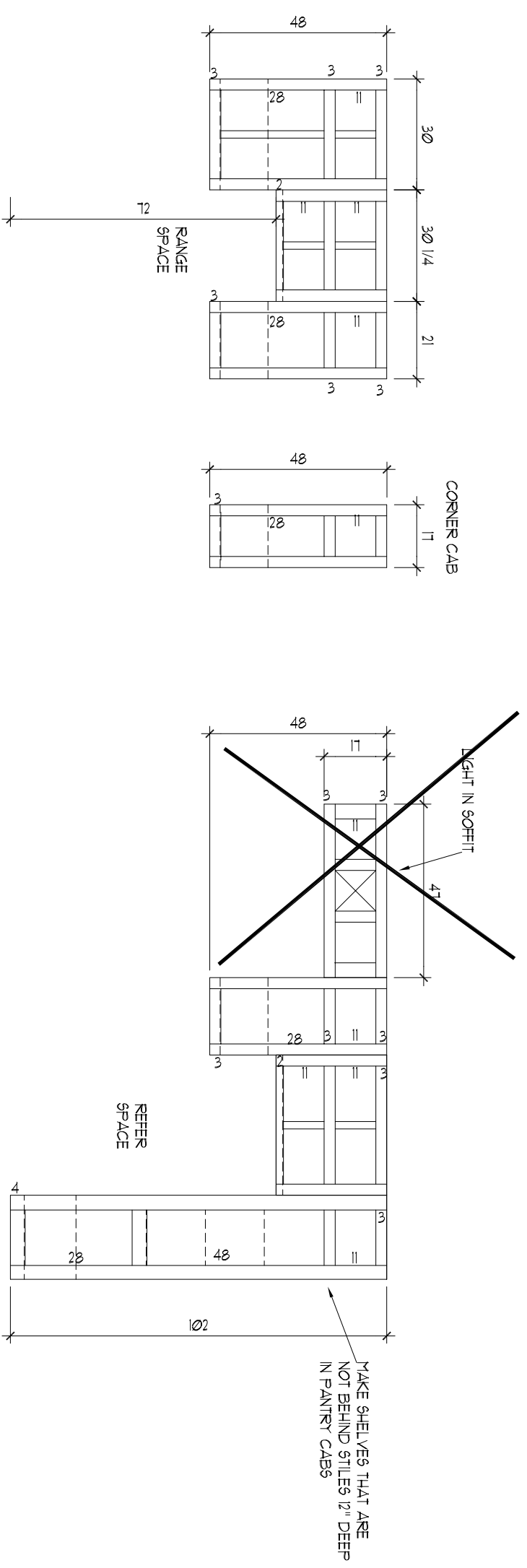

ELEVATION

DRAWERS			
DOORS			
CABINET TOP LEGEND			
—	SELF-EDGE		
—	FULL RETURN / NO BACKING		
—	RAW EDGE		
—	BACKSPLASH		

Manufacturing West, Inc.
 Albany Division - Plant #972
 2445 S.W. PACIFIC BLVD.
 ALBANY, OR 97321
 Phone (541) 926-8631
 Fax (866) 491-6847

DRAWING TITLE: **KITCHEN CABINETS**
 ORIGINAL DRAWING BY: —
 SIDEWALL: 4" OR 6" **6" WALLS**
 PRODUCT: Inspiration MODEL NO. **INS 382F**
 SQ. FT. DATE: 1-8-15
 SHEET 5-4 REVISED —

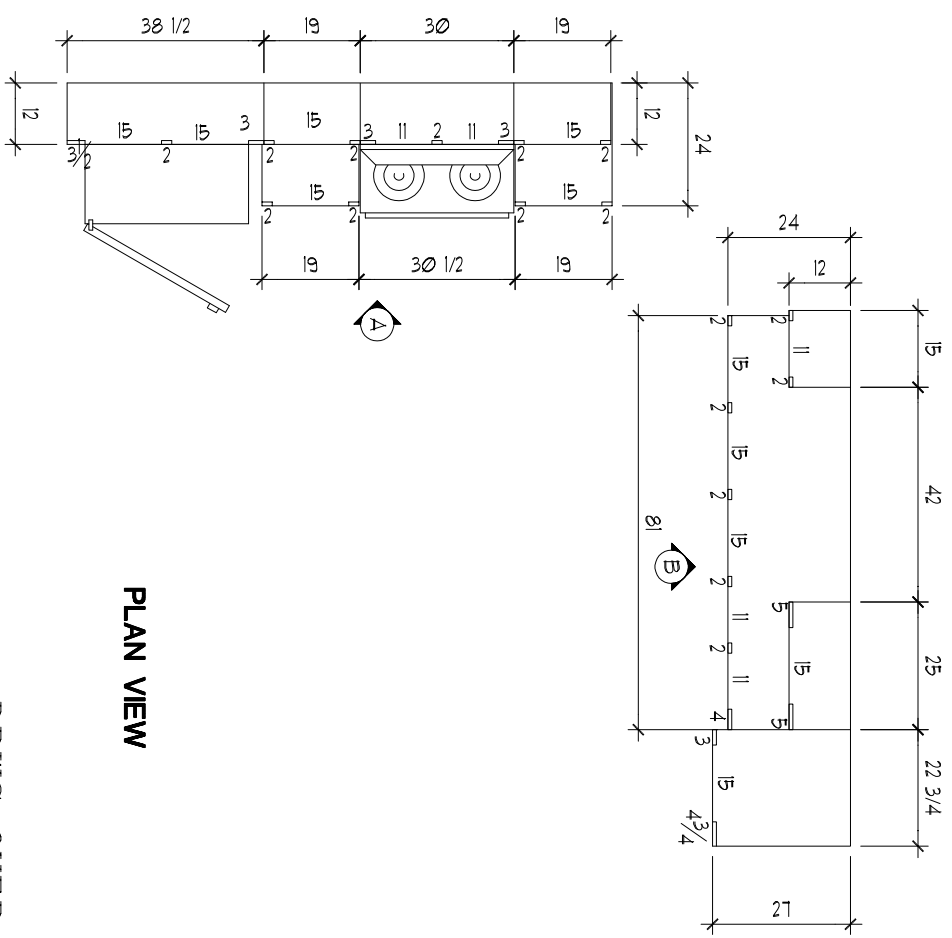

PLAN VIEW

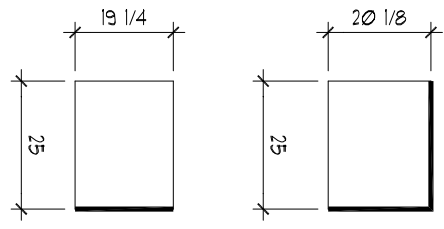

COUNTERTOPS

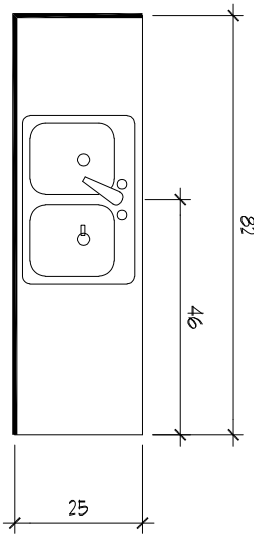

DRWS OVER DOORS PER ORDER

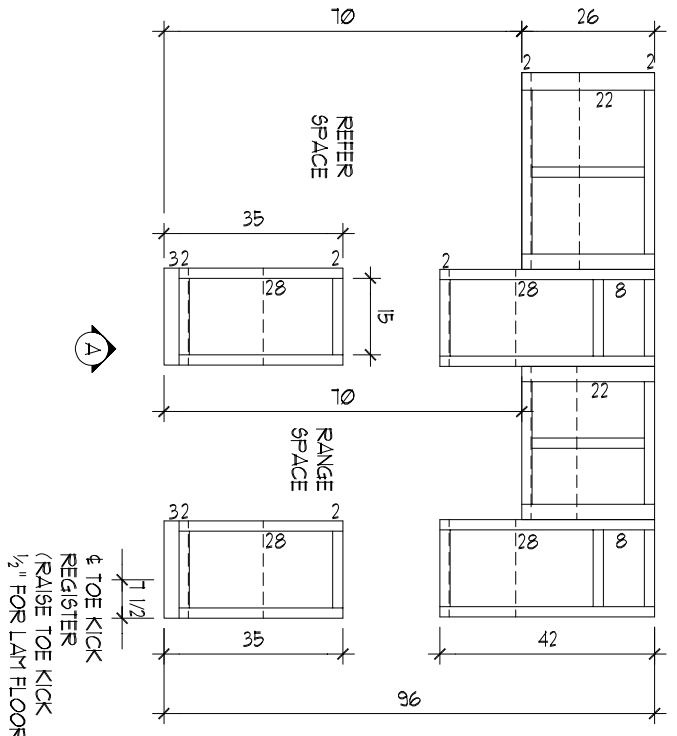

ELEVATION

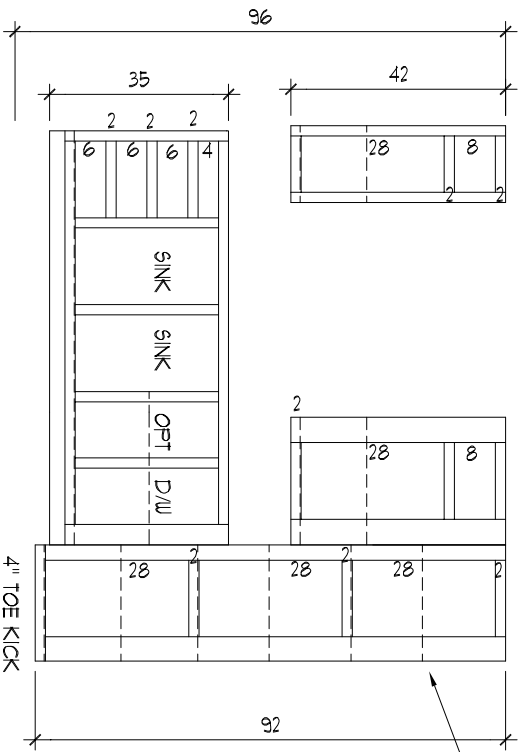

MAKE SHELVES THAT ARE NOT BEHIND STILES 1/2" DEEP IN PANTRY CABS

DRAWING TITLE		KITCHEN CABINETS	
ORIGINAL DRAWING BY :		G. LUND	
SIDEWALL: 4" OR 6"		6" WALLS	
PRODUCT	MODEL NO.	INS 382F	
Inspiration	DATE	1-8-15	
SQ. FT.	REVISED	-	
SHEET		5-C	

DRAWERS		-	-
DOORS		-	-

CABINET TOP LEGEND	
—	SELF-EDGE
---	FULL RETURN / NO BACKING
---	RAW EDGE
---	BACKSPLASH

Manufacturing West, Inc.
 Albany Division - Plant #972
 2445 S.W. PACIFIC BLVD.
 ALBANY, OR 97321
 Phone (541) 926-8631
 Fax (866) 491-6847

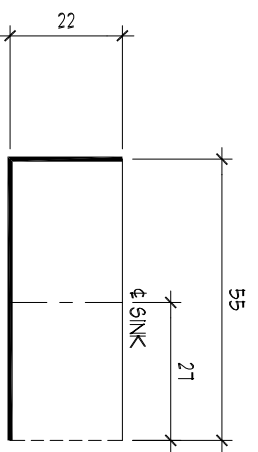

COUNTER TOP

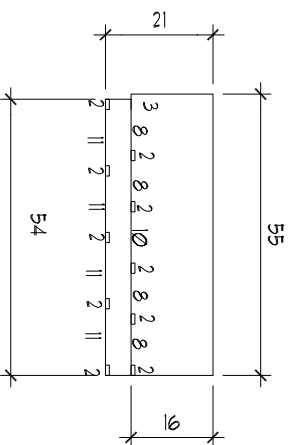

PLAN VIEW

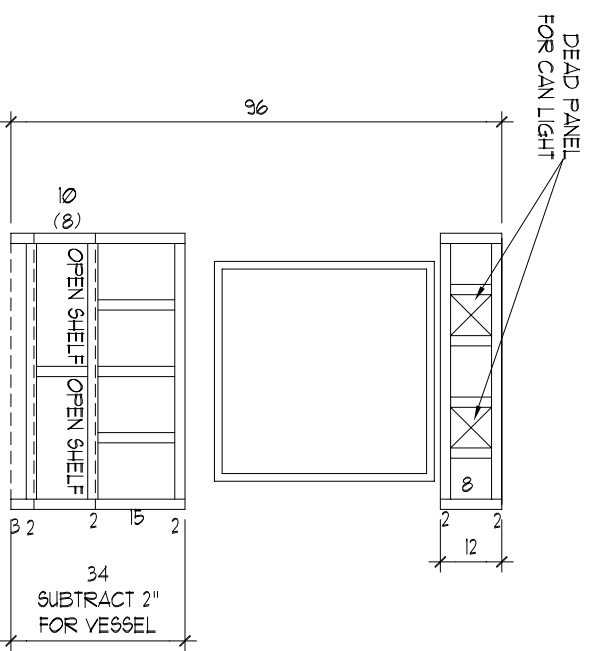

ELEVATION

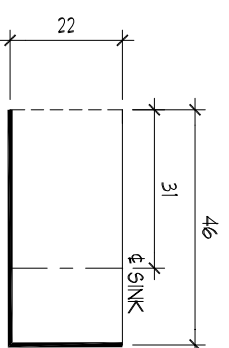

COUNTER TOP

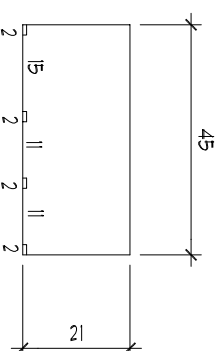

PLAN VIEW

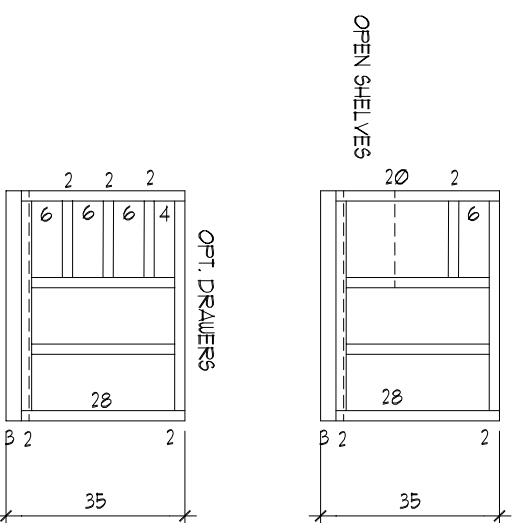

ELEVATION

① DOORS & DRAWERS ② DOORS & DRAWERS

-	-	-	-
-	-	-	-
-	-	-	-
-	-	-	-
③ DOORS & DRAWERS	④ DOORS & DRAWERS	-	-
-	-	-	-
-	-	-	-
-	-	-	-
-	-	-	-

Manufacturing West, Inc.
 Albany Division - Plant #972
 2445 S.W. PACIFIC BLVD.
 ALBANY, OR 97321
 Phone (541) 926-8631
 Fax (866) 491-6847

DRAWING TITLE
LAVY CABINETS

ORIGINAL DRAWING BY :
 SIDEWALL: 4" OR 6" **6" WALLS**

PRODUCT MODEL NO.
 Inspiration **INS 382F**

DATE
 1-8-15

SHEET **7-A** REVISED

