



JACKSON HIGHWAY WAREHOUSE
TRAFFIC IMPACT ANALYSIS

Lewis County, WA



02/22/2022

Prepared for: Mr. Joel Molander
Puget Western, Inc.
P.O. Box 1529
Bothell, WA 98011

Updated
February 2022

JACKSON HIGHWAY WAREHOUSE
TRAFFIC IMPACT ANALYSIS

TABLE OF CONTENTS

1. Introduction.....	3
2. Project Description	3
3. Existing Conditions	6
4. Future Traffic Conditions	10
5. Summary	18

Appendix

LIST OF TABLES

1. Baseline 2020 PM Peak Hour Level of Service	9
2. Project Trip Generation	10
3. Forecast 2025 PM Peak Hour Level of Service	16
3. Forecast 2025 AM/PM Peak Hour Level of Service with Project	17

LIST OF FIGURES

1. Vicinity Map & Roadway System	4
2. Site Plan	5
3. Baseline 2020 PM Peak Hour Volumes.....	7
4A. PM Peak Hour Trip Distribution & Assignment – Scenario 1: No Easement	12
4B. PM Peak Hour Trip Distribution & Assignment – Scenario 2: With Easement.....	13
5. Forecast 2025 PM Peak Hour Background Volumes	14
6. Forecast 2025 PM Peak Hour Volumes with Project	15

JACKSON HIGHWAY WAREHOUSE TRAFFIC IMPACT ANALYSIS

1. INTRODUCTION

The intent of this Transportation Impact Analysis (TIA) is to provide an update to the original TIA (December 7, 2020) based on Lewis County's SEPA Comment Letter (November 9, 2021) requesting further evaluation with respect to Jackson Highway & Rush Road intersection. See appendix for comment letter for reference. Additional field counts were taken during the requested AM timeframe to provide additional intersection operation and left-turn assessments. This report is a continuation and uses data from the original report.

2. PROJECT DESCRIPTION

Jackson Highway Warehouse is a proposed 1,001,615 square foot industrial building located in the Chehalis Urban Growth Area of Lewis County. The subject property is bordered to the northeast by Jackson Highway on a cumulative 69.64-acres within tax parcel #'s: 01780000-1009; -3000; & -1010. The lot is largely undeveloped with the exception of a few on-site structures near the east end of the property which are to be removed for new construction. Access to the site is proposed via two driveways extending southwest from Jackson Highway. Also considered, is an alternative scenario with a third access point by way of an easement to Rush Road, opposite Maurin Road. Illustrated below is an aerial image demarcating the subject lot boundaries. Figure 1 on the following page identifies the adjacent street system and general project vicinity. A conceptual site plan of the project is presented in Figure 2.



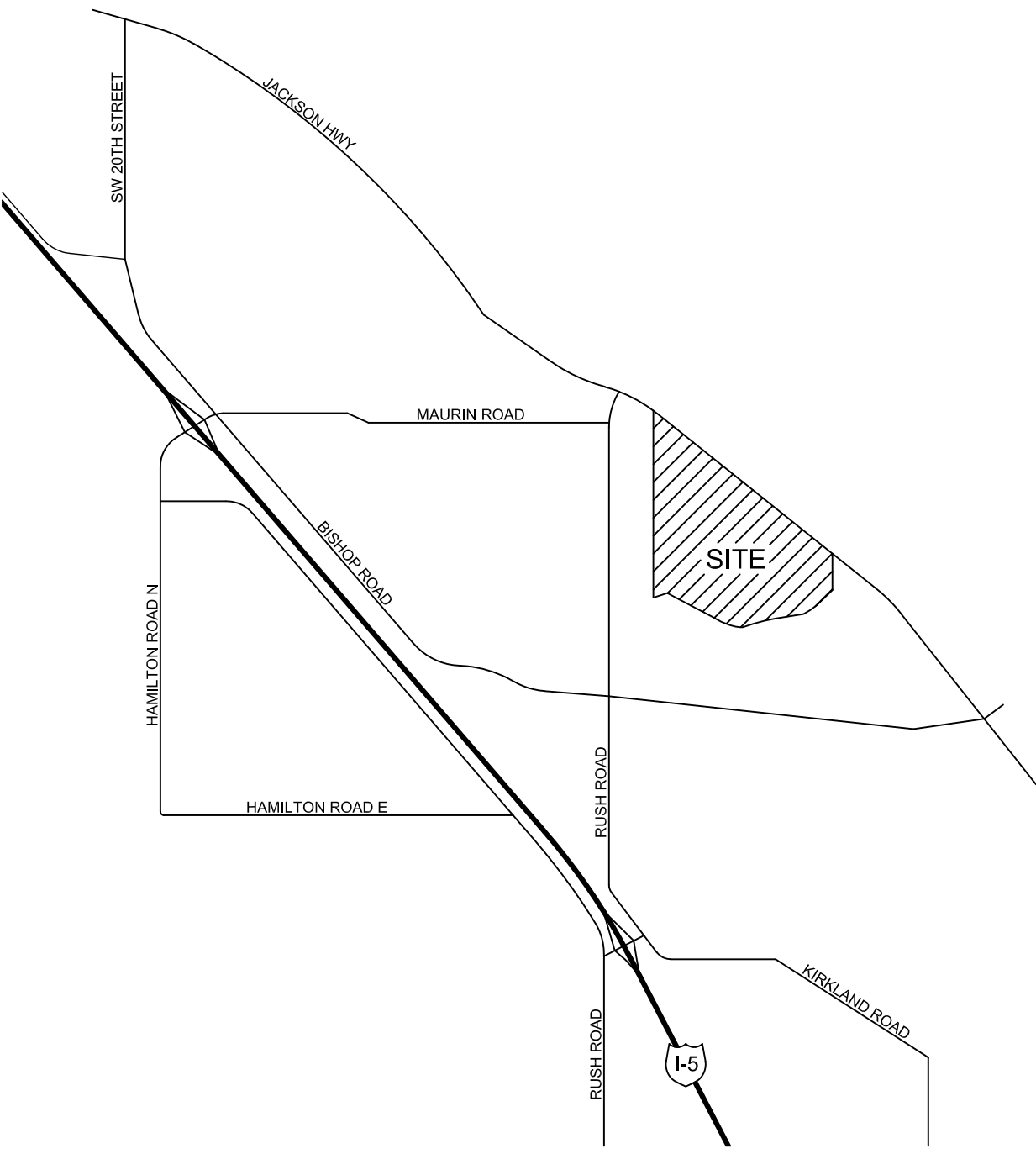

HEATH & ASSOCIATES
TRAFFIC AND CIVIL ENGINEERING

JACKSON HIGHWAY WAREHOUSE
VICINITY MAP & ROADWAY SYSTEM
FIGURE 1

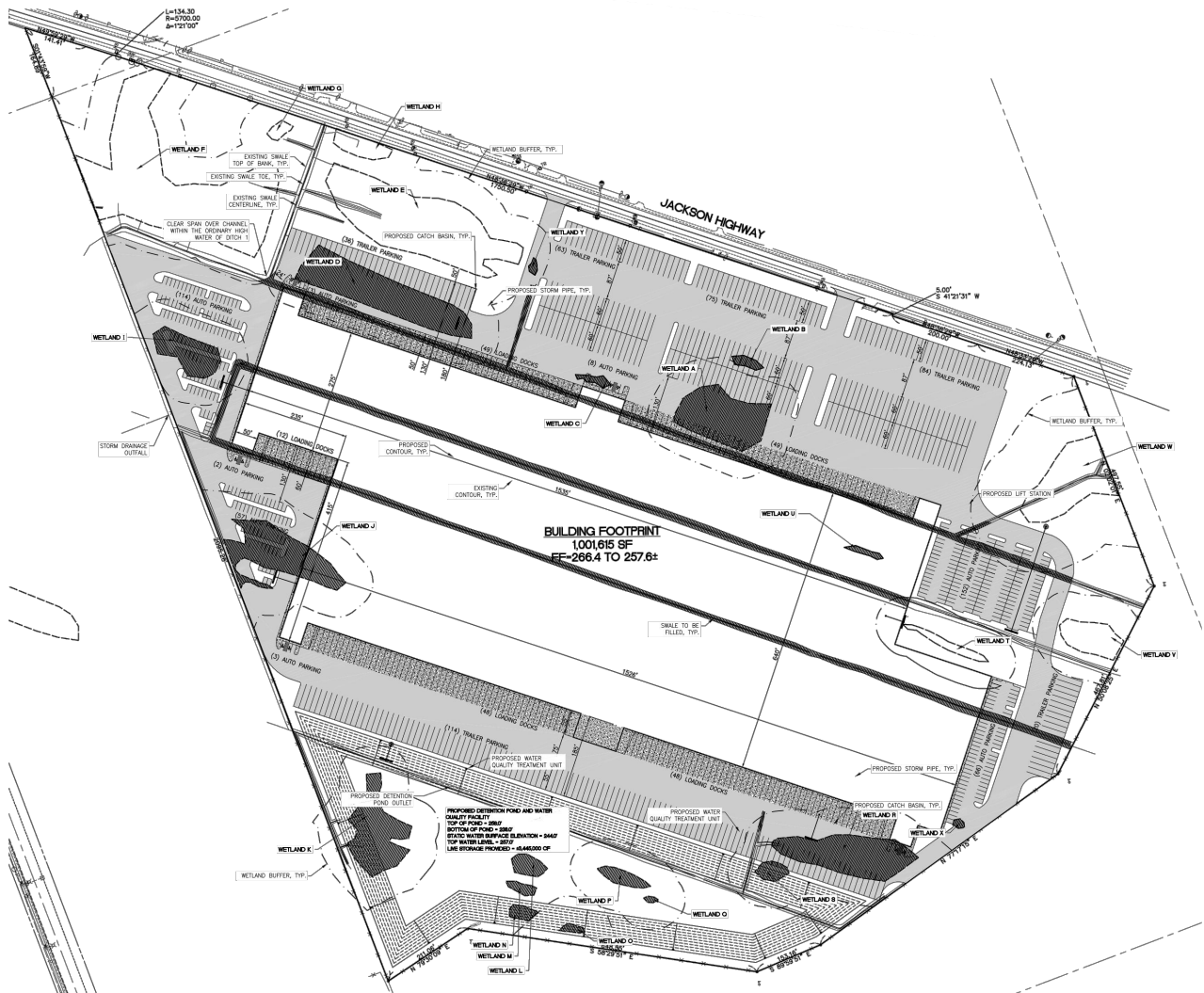

HEATH & ASSOCIATES
TRAFFIC AND CIVIL ENGINEERING

JACKSON HIGHWAY WAREHOUSE

SITE PLAN
FIGURE 2

3. EXISTING CONDITIONS

3.1 Existing Roadway Characteristics

The main arterial serving the subject site is listed and described below.

Jackson Highway: is a northwest-southeast, two-lane arterial bordering the subject site to the northeast. Travel lanes are approximately 11-feet in width. Shoulders are composed of paved segments 4- to 8-feet in width. No non-motorist facilities are present in the area. The roadway has a posted speed limit of 40 mph in the vicinity of the subject site.

3.2 Pedestrian and Bicycle Activity

During field observations, no non-motorist transport was observed along Jackson Highway. The area is rural in nature with limited walkable amenities. No significant increase with respect to non-motorist transport would be expected from the development given the limited non-motorist infrastructure in the vicinity of the subject site.

3.3 Existing Peak Hour Volumes and Patterns

Field data for this study was collected in October of 2020 and again in January of 2022 (Rush Road & Jackson Hwy per County request) between 7:00-9:00 AM). Traffic counts were taken at the following intersections, which would receive the bulk of the anticipated vehicular demands:

- Rush Rd & I-5 SB Ramps
- Rush Rd & I-5 NB Ramps
- Rush Rd & Kirkland Rd
- Rush Rd & Bishop Rd
- Rush Rd & Maurin Rd
- Rush Rd & Jackson Hwy
- Labree Rd & I-5 SB Ramps
- Labree Rd & I-5 NB Ramps

Data was obtained during evening peak period between the hours of 4:00 PM – 6:00 PM, which generally translates to highest overall roadway volumes in a given 24-hour period. The one hour reflecting highest overall roadway volumes (peak hour) was then derived from these counts.

Additionally, the WSDOT COVID-19 Transportation System Performance Multimodal Executive Summary showed that traffic volumes in the area along state facilities in Lewis County were on average 4% lower than typical baseline conditions on the date the count was taken. To remain conservative in analysis, existing PM peak hour volumes were increased by 5%. Adjusted baseline 2020 PM peak hour volumes at the study intersections are illustrated in Figure 3 on the following page. Full-count sheets have been included in the appendix.

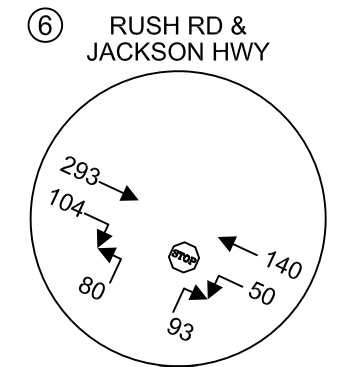
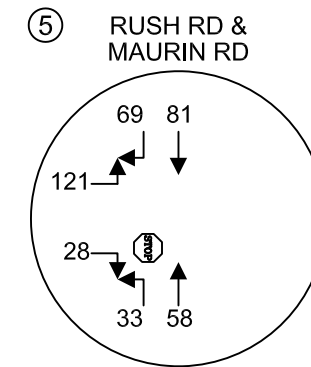
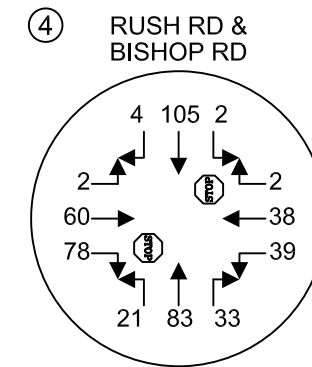
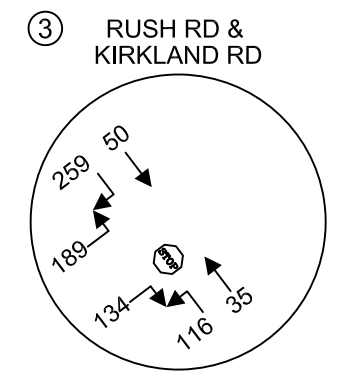
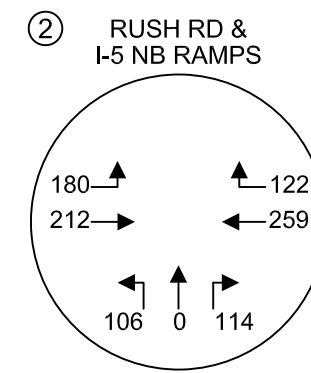
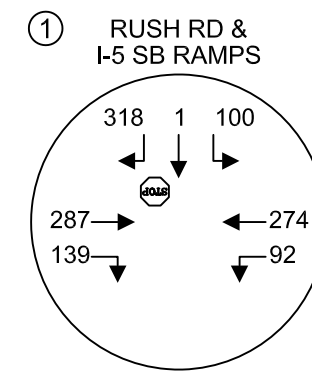
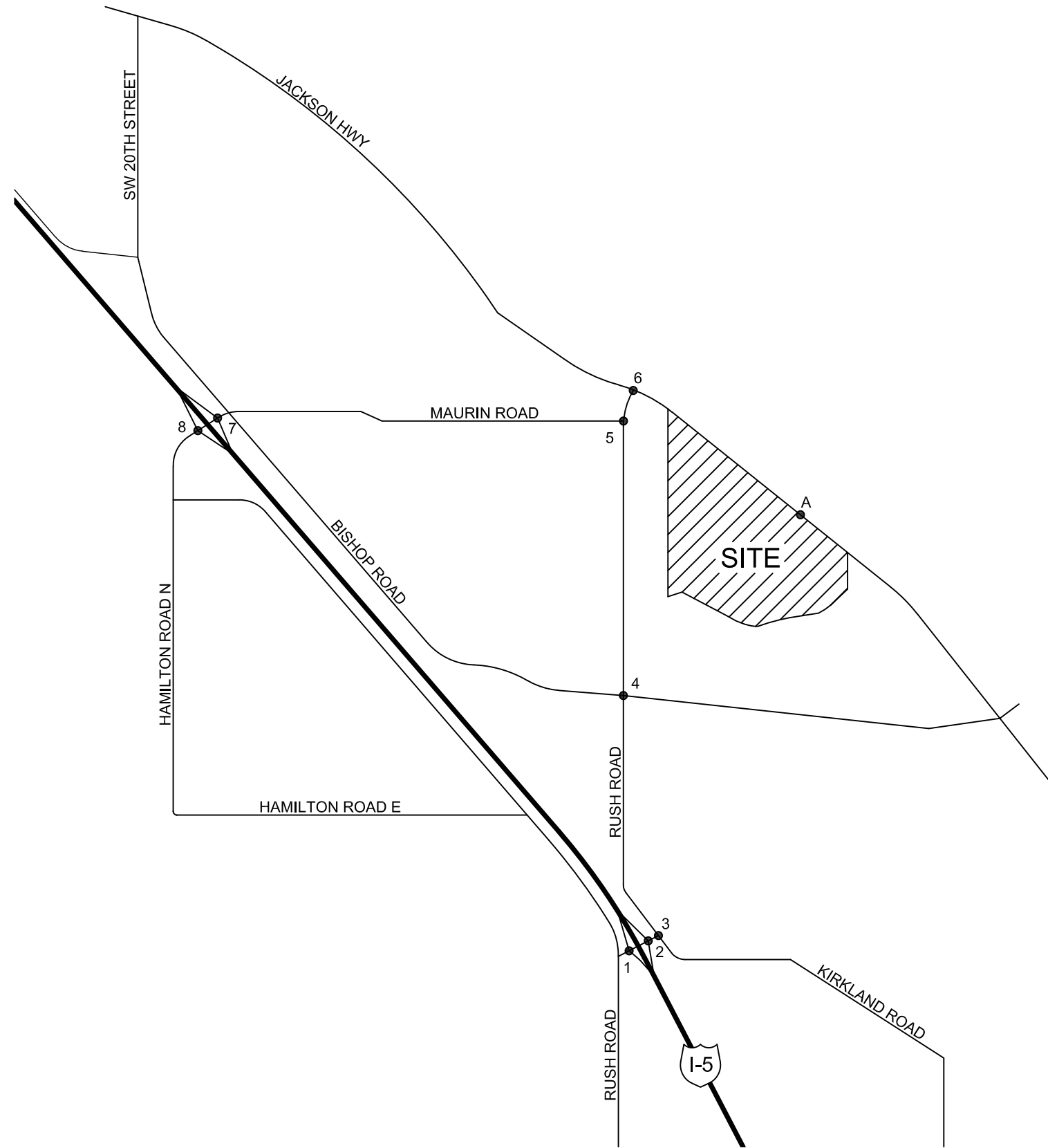

2022 AM PEAK HOUR

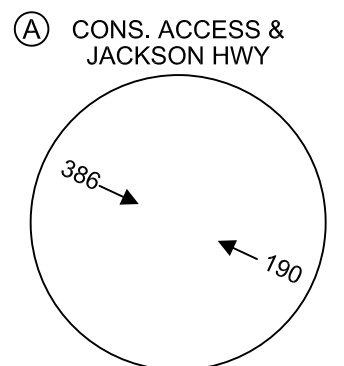
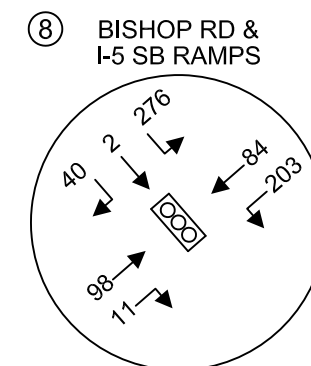
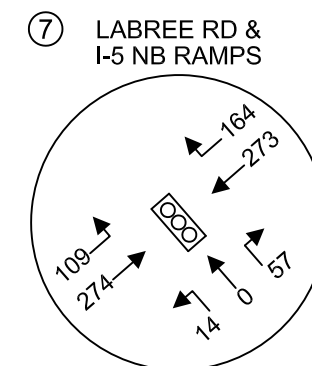
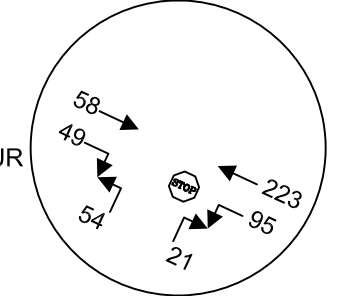

3.4 Public Transit

A review of the Twin Transit regional bus schedule indicates that Route 444 – Downtown Chehalis provides service in the vicinity of the subject site. While the nearest stop in relation to the development is provided at Maurin Road & Rush Road (0.15 miles west), riders may flag down a bus at any safe and visible area along the route. Weekday service is provided from 7:00 AM – 7:00 PM (60-minute headways) while weekend service is provided from 7:00 AM – 3:00 PM (60-minute headways). Refer to the Twin Transit bus schedule for further details. As part of site development, bus pullouts may be constructed along Jackson Hwy. Additional coordination with County and Twin Transit is taking place for final requirements.

3.5 Roadway Improvements

A review of the City of Chehalis Six-Year (2021-2026) Transportation Improvement Program indicates no following planned project in the general area. A review of the Lewis County Six-Year (2021-2026) Transportation Improvement Program indicates the following planned projects in the general area.

Rush Road Improvements (Bishop Road to s/o Holloway Drive; Priority #15): This project entails a major widening of the roadway to include curb, gutter sidewalk and more. Local funds allocated to the project total \$2,280,000 and construction is to begin in 2023.

Downie Road Extension (southerly extension; Priority #25): This project entails extending the roadway south to Maurin Road. Federal discretionary funding totals \$1,200,000 and construction is to begin in 2025.

3.6 Site Access & Driveway Design

As shown in the provided site plan, two driveways extending southwest from Jackson Highway are proposed. An alternative access on Rush Road and opposite Maurin Road may be available via an easement. All proposed driveways shall maintain and allow for clear sight lines as prescribed in the County engineering and AASHTO¹ standards. As the site would generate a portion of truck traffic, sight lines along the 40-mph Jackson Highway should measure 680 feet to accommodate heavy vehicles. Based on preliminary measurements of Jackson Highway, sight lines can be achieved. The roadway is relatively flat in grade and no horizontal curvature exists that would obstruct the needed visibility for project traffic to safely enter the roadway.

¹ A Policy on Geometric Design of Highways and Streets, AASHTO, 7th Edition, 2018.

3.7 Level of Service

Baseline intersection delays were determined through the use of the *Highway Capacity Manual* 6th Edition. Capacity analysis is used to determine level of service (LOS) which is an established measure of congestion for transportation facilities. The range² for intersection level of service is LOS A to LOS F with the former indicating the best operating conditions with low control delays and the latter indicating the worst conditions with heavy control delays. Detailed descriptions of intersection LOS are given in the 2016 Highway Capacity Manual. Level of service calculations were made through the use of the *Synchro 10* analysis program. For side-street, stop-controlled intersections, LOS is determined by the approach with the highest delay. Delays presented represent overall weighted average delays for signalized intersections. Table 1 below presents baseline 2020 PM peak hour LOS delays for the key intersection of study.

Table 1: Baseline 2020 PM Peak Hour Level of Service

Delays given in seconds per vehicle

Intersection	Control	Movement	LOS	Delay
Rush Rd & I-5 SB Ramps	Stop	SB	C	17.6
Rush Rd & I-5 NB Ramps	Stop	NB	C	22.5
Rush Rd & Kirkland Rd	Stop	EB	B	14.2
Rush Rd & Bishop Rd	Stop	WB	B	12.4
Rush Rd & Maurin Rd	Stop	EB	B	11.2
Rush Rd & Jackson Hwy	Stop	NB	B	12.3
Labree Rd & I-5 NB Ramps	Signalized	Overall	B	14.5
Labree Rd & I-5 SB Ramps	Signalized	Overall	B	19.8

SB: Southbound; NB: Northbound; EB: Eastbound; WB: Westbound

Existing PM peak hour conditions are shown to operate with LOS C or better conditions indicating stable operations during the critical PM peak hour of travel.

² *Signalized Intersections - Level of Service*

Level of Service	Control Delay per Vehicle (sec)
A	≤ 10
B	> 10 and ≤ 20
C	> 20 and ≤ 35
D	> 35 and ≤ 55
E	> 55 and ≤ 80
F	> 80

Stop Controlled Intersections – Level of Service

Level of Service	Control Delay per Vehicle (sec)
A	≤ 10
B	> 10 and ≤ 15
C	> 15 and ≤ 25
D	> 25 and ≤ 35
E	> 35 and ≤ 50
F	> 50

Highway Capacity Manual, 6th Edition

4. FUTURE TRAFFIC CONDITIONS

4.1 Trip Generation

Trip generation is used to determine the magnitude of project impacts on the surrounding street system. This is usually denoted by the quantity or specific number of new trips that enter and exit a project during a designated time period, such as a specific peak hour (AM or PM) or an entire day. Data presented in this report was taken from the Institute of Transportation Engineer's publication *Trip Generation*, 10th Edition. The designated land use for this project is defined as High-Cube Transload and Short-Term Storage Warehouse (LUC 154). Table 2 below summarizes the estimated project trip generation using square footage as the input variable and ITE average rates to determine trip ends. Included are the average weekday daily traffic (AWDT) and the AM and PM peak hours. Refer to the appendix for trip generation output.

Table 2: Project Trip Generation

Land Use	Size	AWDT	AM Peak-Hour Trips			PM Peak-Hour Trips		
			In	Out	Total	In	Out	Total
Warehouse	1,001,615 sf	1402	62	18	80	28	72	100

Based on ITE data, the project is anticipated to generate 1402 new daily weekday trips with 80 trips occurring in the AM peak hour (62 inbound / 18 outbound) and 100 in the PM peak hour (28 inbound / 72 outbound). It should be noted that a portion of these trips are anticipated to be in the form of heavy vehicles (25% in the AM peak hour / 10% in the PM peak hour) according to ITE data.

4.2 Trip Distribution and Assignment

Trip distribution can be described as the travel routes to/from the subject site relative to the adjacent street system. The specific destinations and origins of the generated traffic primarily influence the key study intersections, which will effectively receive the bulk of project impacts. The trips generated by the project are expected to follow the general trip pattern as shown in Figure 4A for the PM peak hour. This distribution allocates all project generated traffic to a single, consolidated access off Jackson Highway. Additionally, an easement is being discussed that would extend an access roadway through the neighboring property to the west, providing connection from the property to the Rush Road & Maurin Road intersection. PM peak hour trip distribution illustrating this easement Scenario is presented in Figure 4B.

An additional AM peak hour trip distribution exhibit has been prepared and is available in the appendix for reference.

4.3 Future Peak Hour Volumes

A 5-year horizon of 2025 was used for future traffic delay analysis. The proposed development is located within the Chehalis Urban Growth Area of Lewis County. The City is forecasted to grow at an annual rate of 1.50%³ according to the Chehalis Comprehensive Plan (2017). Therefore, forecast 2025 background traffic volumes were derived by applying a 1.5 percent compound annual growth rate to the baseline 2020 PM peak hour volumes shown in Figure 3. Forecast 2025 PM peak hour volumes without and with the addition of project-generated traffic (to a consolidated access off Jackson Highway) are shown in Figures 5 and 6, respectively.

³ Chehalis Comprehensive Plan 2017: Chapter 3 Land Use, pg. 4

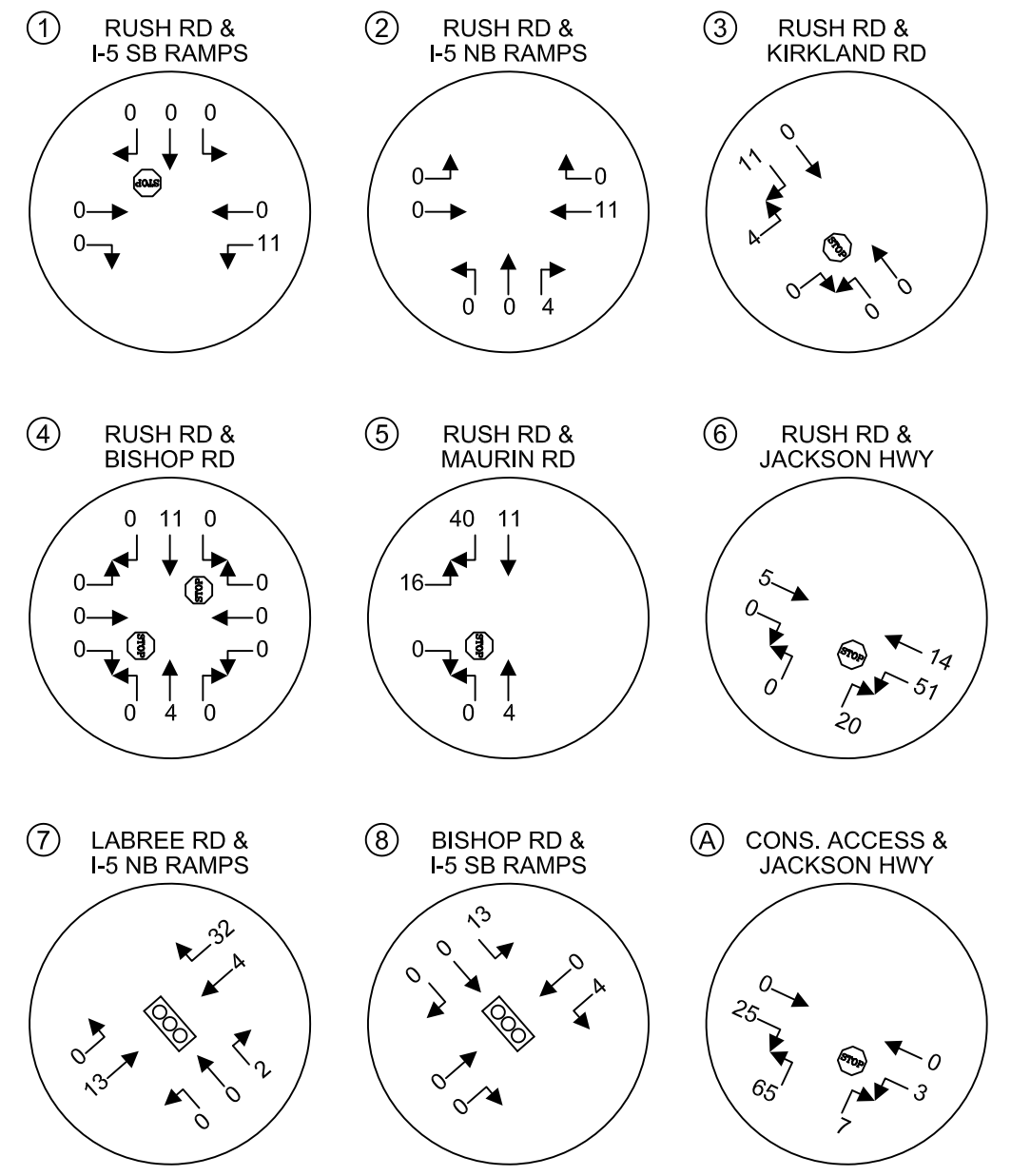
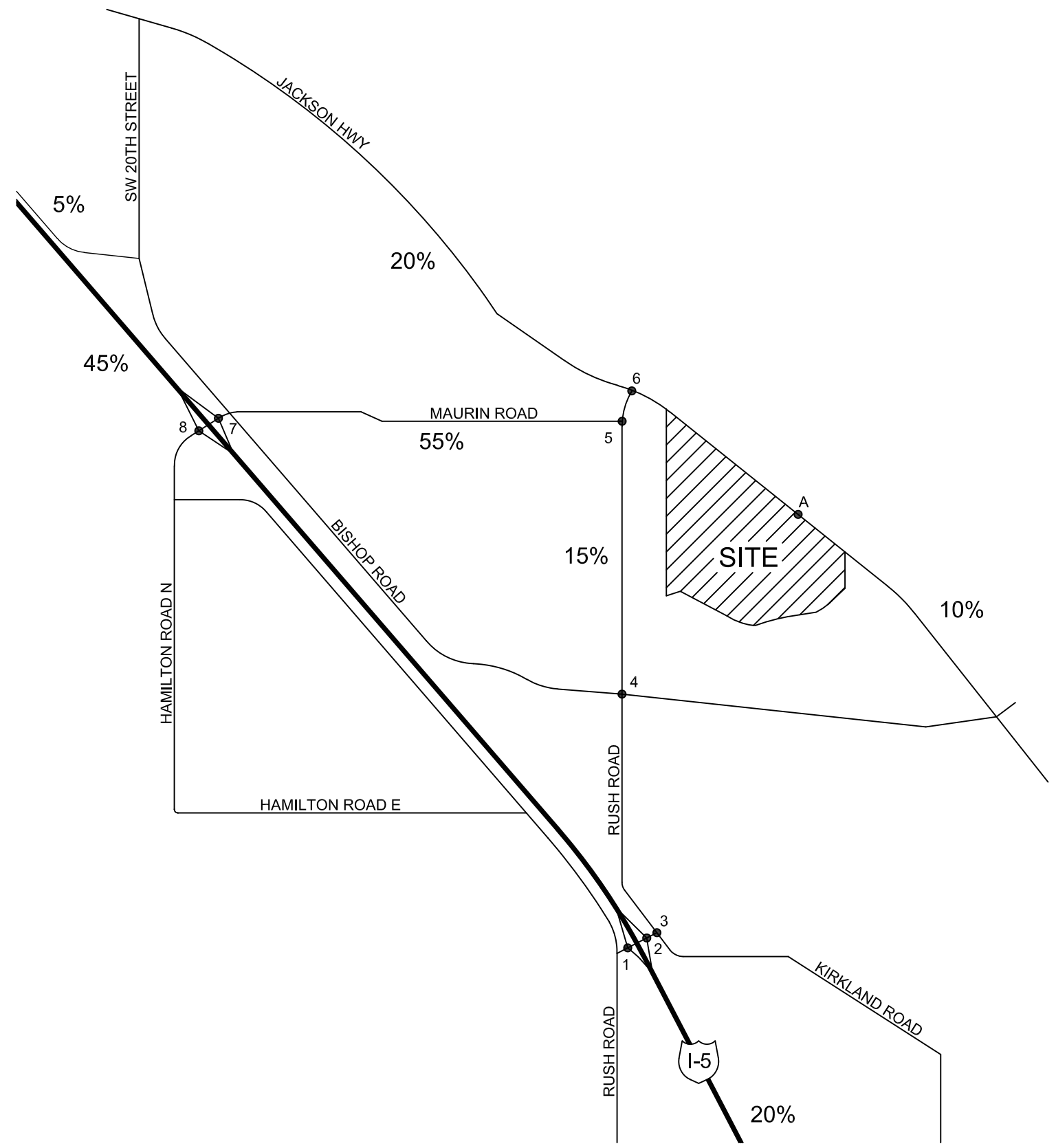

NEW PM PEAK HOUR TRIPS
 INBOUND: 28 VPH
 OUTBOUND: 72 VPH

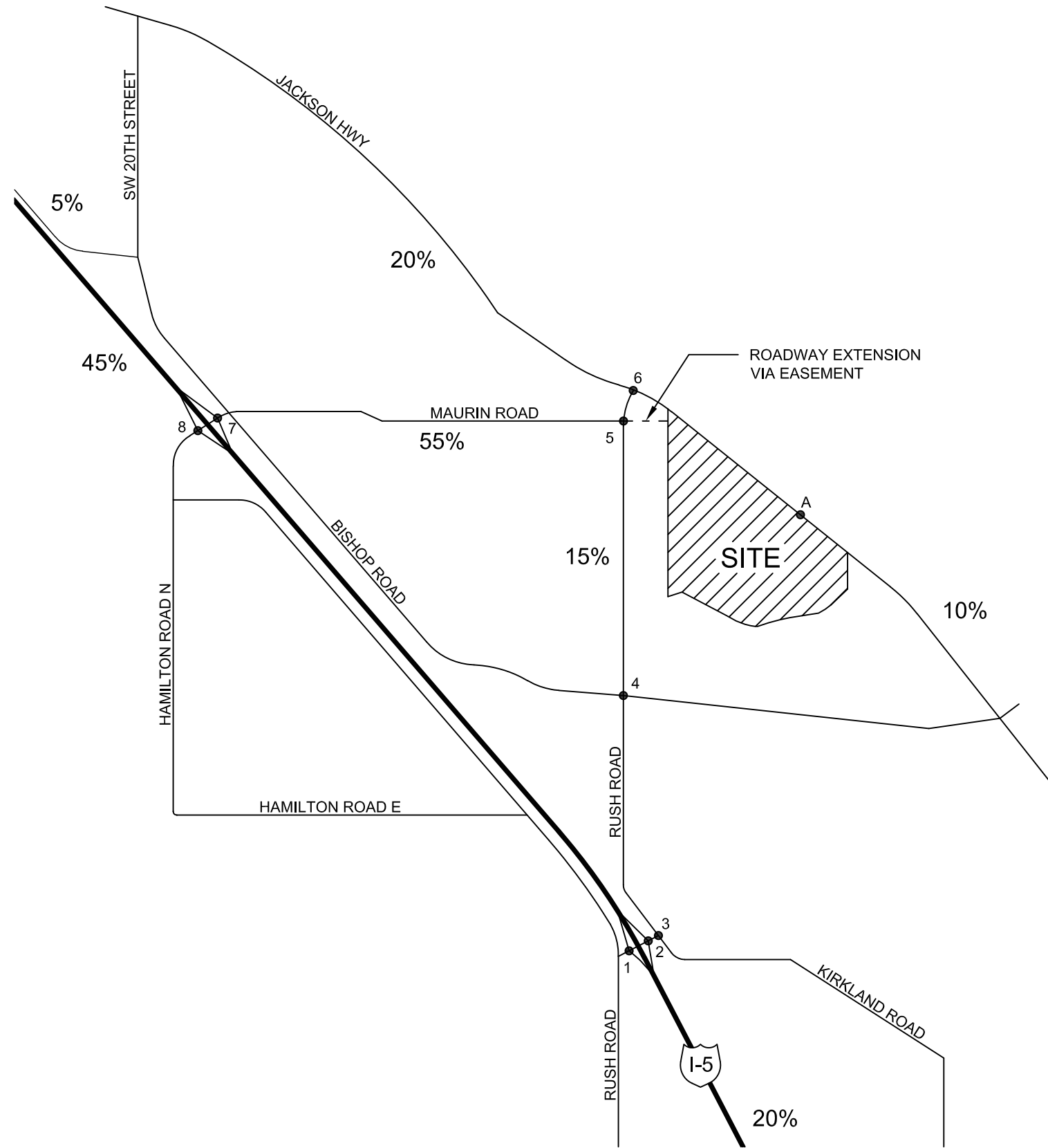

① RUSH RD & I-5 SB RAMPS

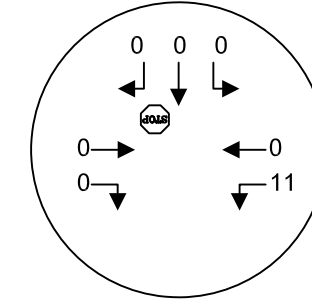

② RUSH RD & I-5 NB RAMPS

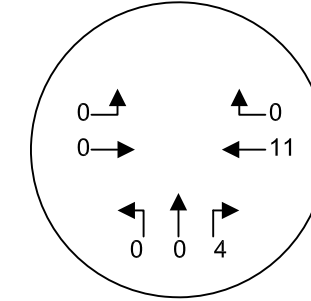

③ RUSH RD & KIRKLAND RD

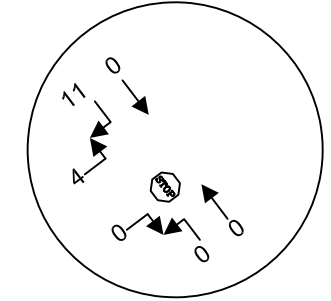

④ RUSH RD & BISHOP RD

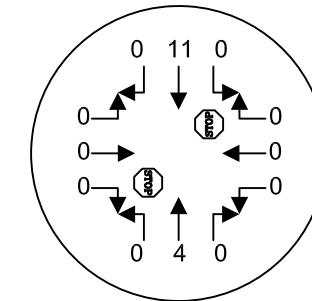

⑤ RUSH RD & MAURIN RD/EXT.

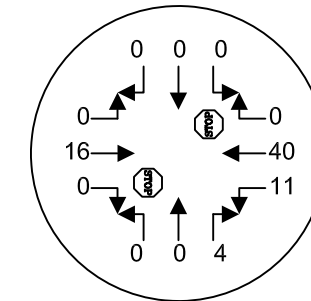

⑥ RUSH RD & JACKSON HWY

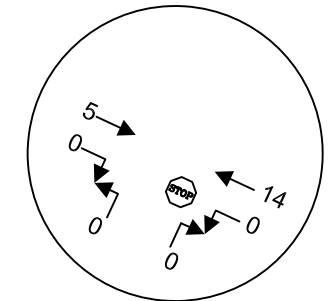

⑦ LABREE RD & I-5 NB RAMPS

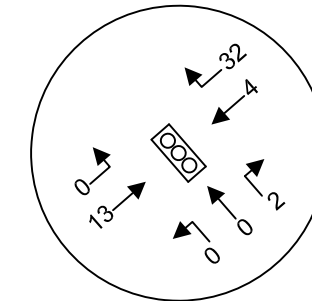

⑧ BISHOP RD & I-5 SB RAMPS

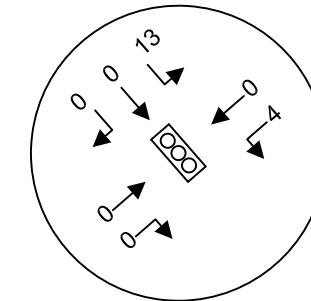

Ⓐ CONS. ACCESS & JACKSON HWY

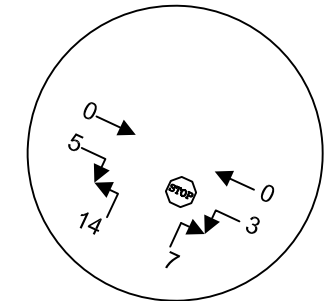

NEW PM PEAK HOUR TRIPS
 INBOUND: 28 VPH
 OUTBOUND: 72 VPH

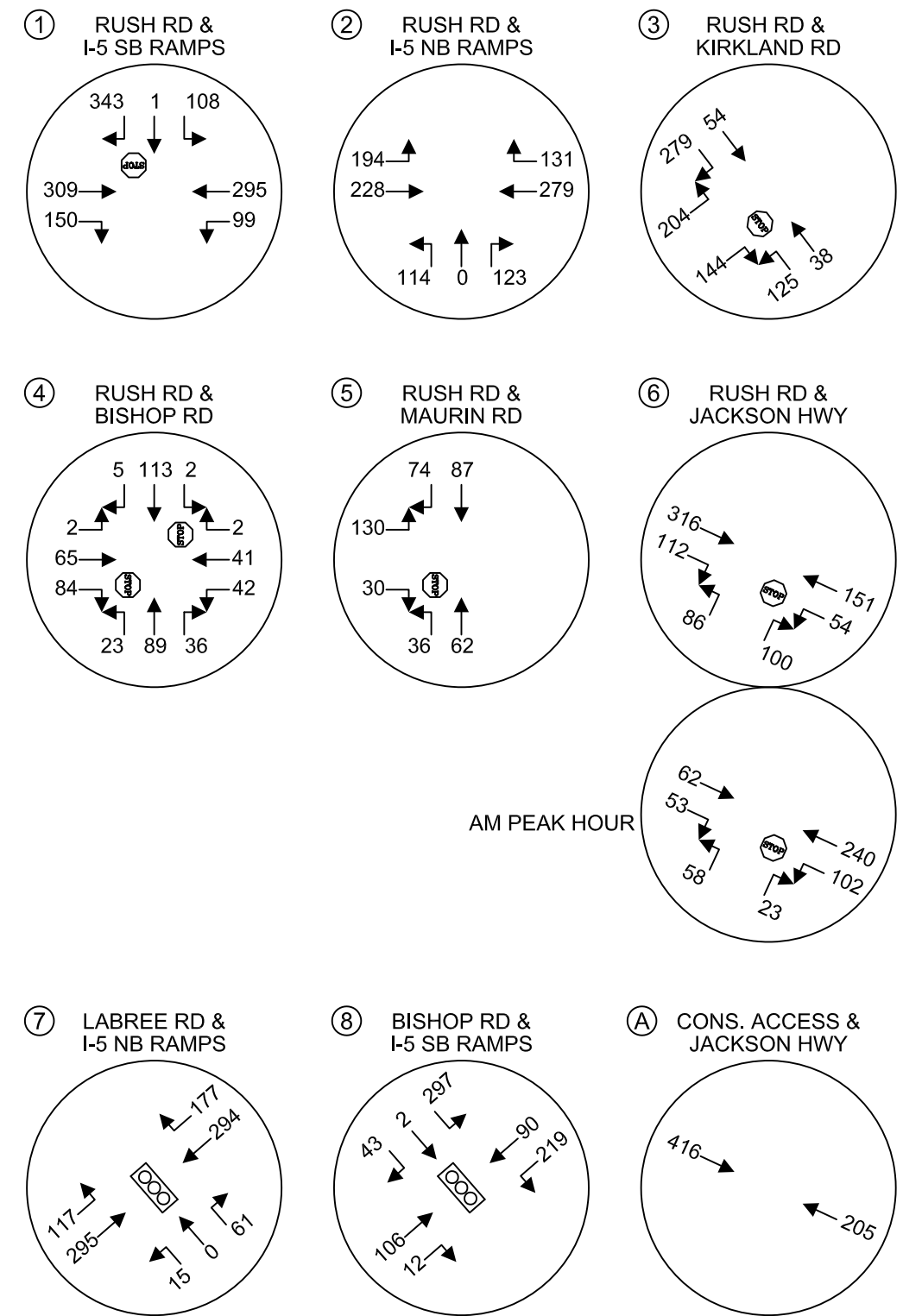
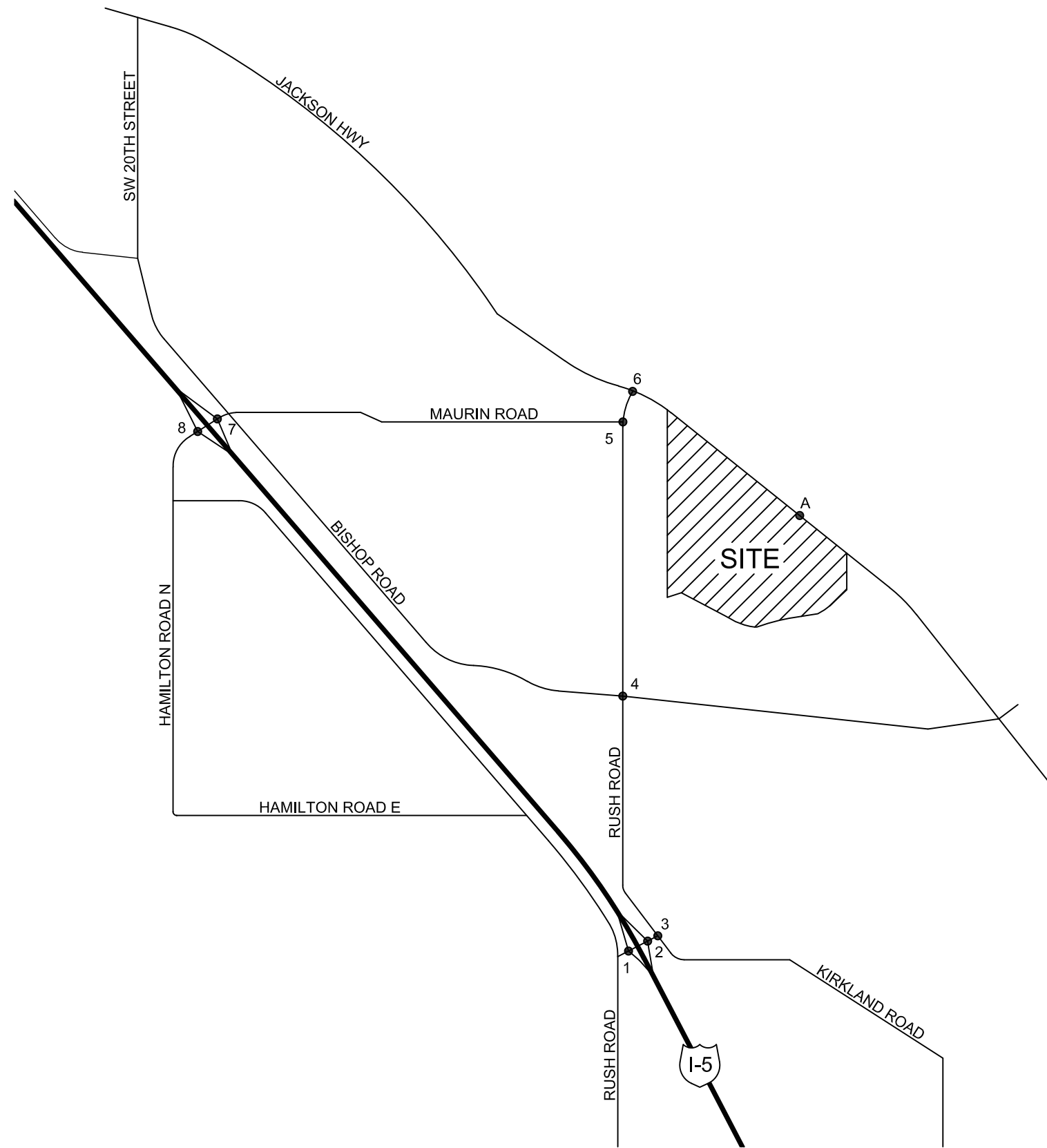

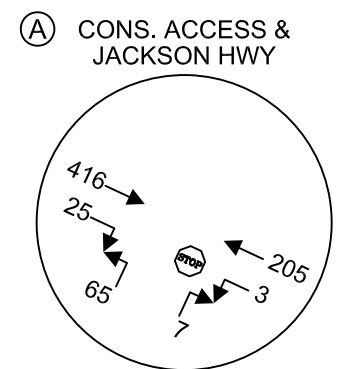
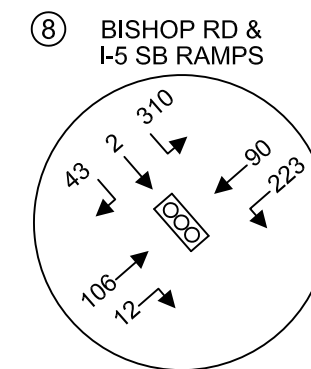
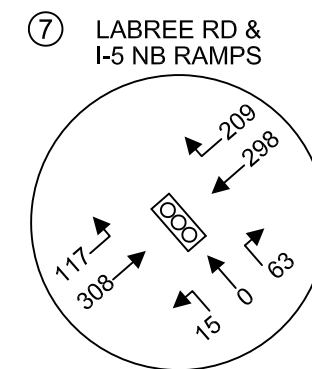
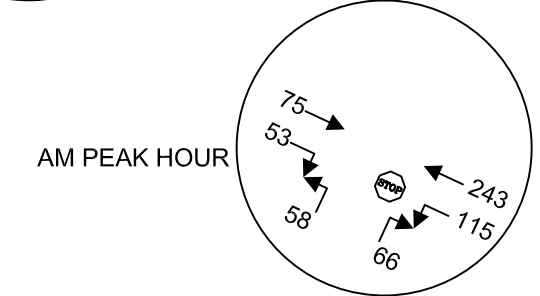
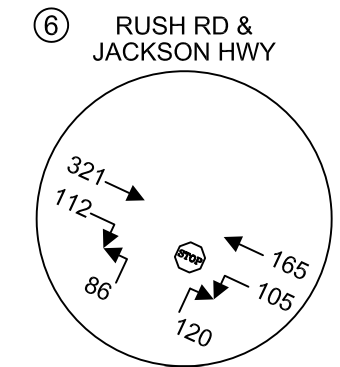
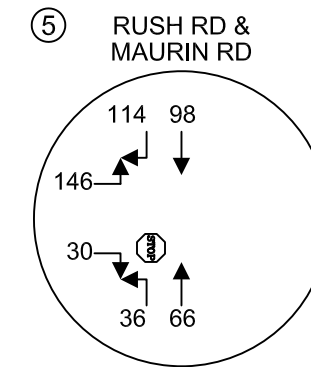
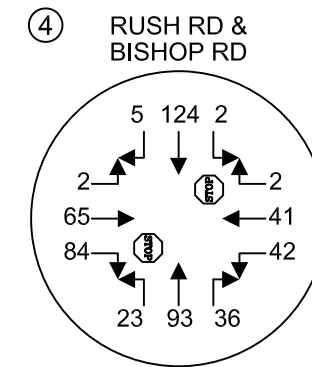
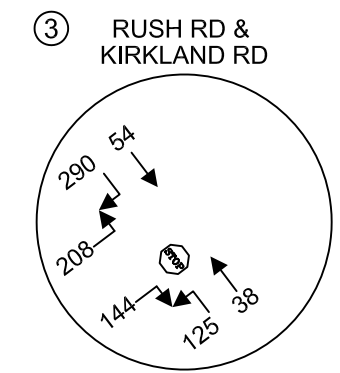
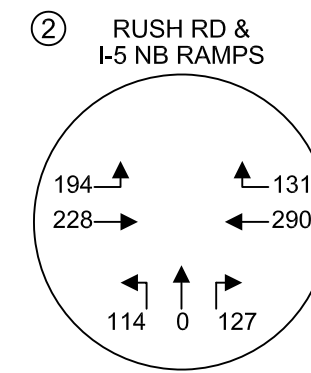
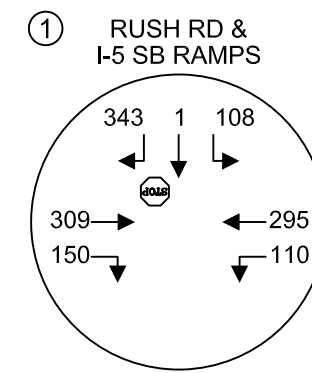
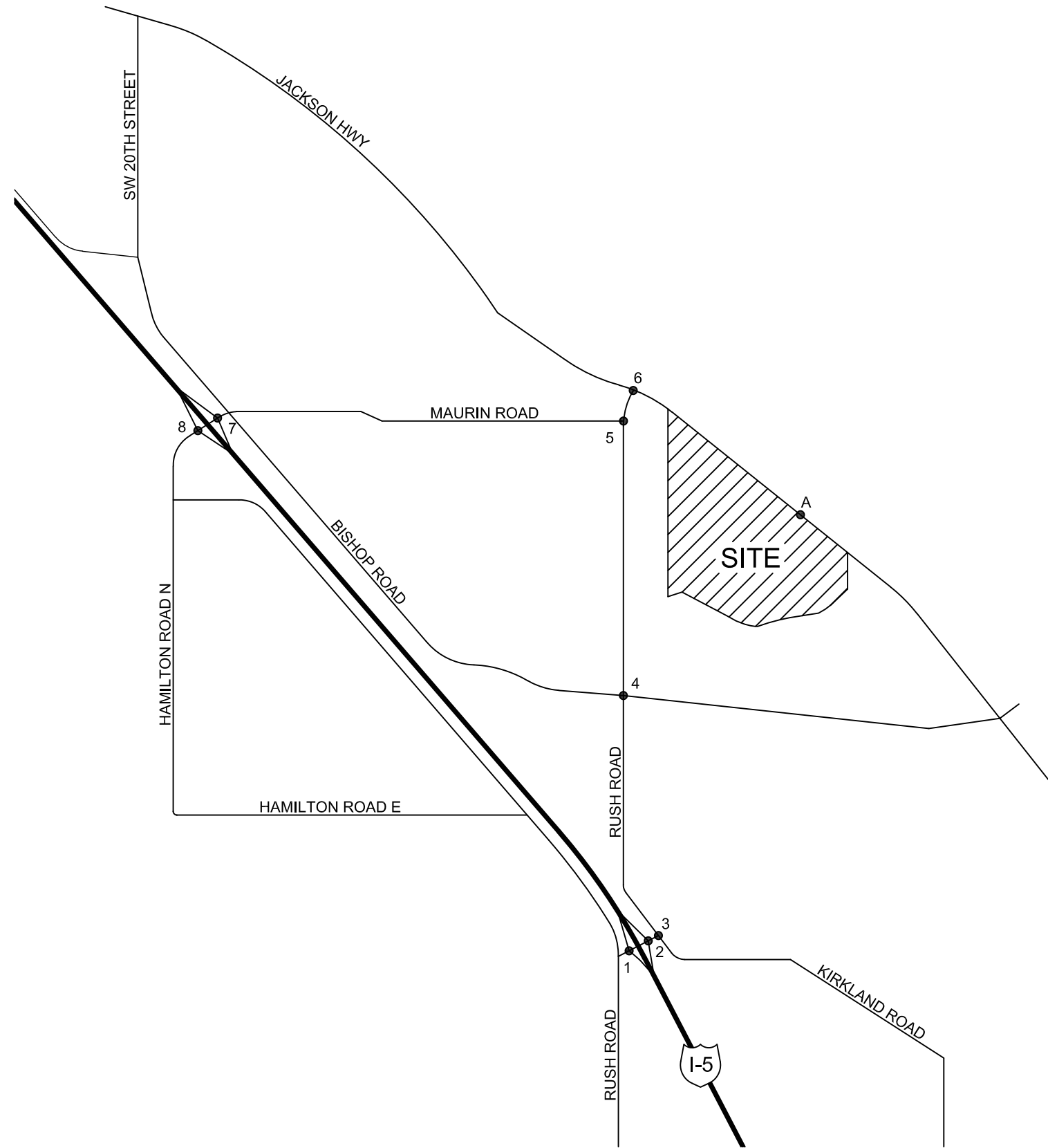

4.4 Future Level of Service

Level of service analyses were made of the future PM peak hour volumes without (background) and with project related trips added to the key roadways and intersections. This analysis once again involved the use of the *Synchro 10* analysis program. Delays for the study intersections and consolidated project access under future conditions are shown below in Table 3.

Table 3: Forecast 2025 PM Peak Hour Level of Service

Delays given in seconds per vehicle

Intersection	Control	Movement	<u>Background</u>		<u>With Project</u>	
			LOS	Delay	LOS	Delay
Rush Rd & I-5 SB Ramps	Stop	SB	C	20.2	C	20.9
Rush Rd & I-5 NB Ramps	Stop	NB	D	28.3	D	28.7
Rush Rd & Kirkland Rd	Stop	EB	C	15.5	C	15.9
Rush Rd & Bishop Rd	Stop	WB	B	13.0	B	13.2
Rush Rd & Maurin Rd	Stop	EB	B	11.6	B	12.3
Rush Rd & Jackson Hwy	Stop	NB	B	12.9	B	14.4
Labree Rd & I-5 NB Ramps	Signalized	Overall	B	14.6	B	14.6
Labree Rd & I-5 SB Ramps	Signalized	Overall	B	20.0	C	20.1
Jackson Hwy & Cons. Access	Stop	NB	-	-	C	15.9

Forecast 2025 PM peak hour Level of Service at the proposed study intersections and access are shown to operate at LOS D or better. No operational deficiencies are identified as a result of the proposed development. It should be noted that this analysis assumed no Rush Road & Maurin Road access to remain conservative and present worst case conditions.

Rush Road & Jackson Highway AM Peak Hour Analysis

As requested in the County’s SEPA comment letter, additional evaluation with respect to Jackson Hwy & Rush Road was needed. See table 4 below for forecast AM peak hour evaluation with project traffic.

Table 4: Forecast 2025 AM/PM Peak Hour Level of Service with Project

Delays given in seconds per vehicle

Intersection	Control	<u>AM Peak Hour</u>		<u>PM Peak Hour</u>	
		LOS	Delay	LOS	Delay
Rush Rd & Jackson Hwy	Stop	B	12.8	B	14.4

The AM Peak hour, using existing traffic counts with growth rate assumption and background traffic added, is shown to operate with LOS B conditions—similar to the PM peak hour.

Left-Turn Warrants

Using WSDOT’s Design Manual Exhibit 1310-7a with forecast 2025 AM peak hour volumes, a left-turn lane was found warranted at Rush Road & Jackson Highway. With an estimated 10-20% heavy vehicle composition, a minimum storage length of 125-feet is recommend based on the peak hour volumes and using WSDOT’s methodology. The project proponent is proposing construction for the left-turn lane at this location as well as along the project’s frontage to facilitate safe ingress/egress.

4.6 Right Turn Warrant Analysis

Investigations of right turn warrants were conducted to assess whether right turn channelization would be needed at the consolidated project entrance on Jackson Highway. The warrant procedure involves using the WSDOT nomograph, Figure 1310-27, which utilizes right turn volumes and approach traffic. Based on 2025 PM peak hour volumes, it was determined that a right turn pocket or taper is not warranted for consideration at the entrance. The nomograph indicates values just below what would trigger consideration for a right turn pocket. It should be noted that the analysis presented was conservative as all volumes were consolidated to a single access location on Jackson Highway when two would be available.

5. SUMMARY

Jackson Highway Warehouse is a proposed 1,000,615 square foot high-cube warehouse located in the Chehalis Urban Growth Area of Lewis County. The subject site is bordered to the northeast by Jackson Highway and is located on a cumulative 69.64-acres within tax parcel #'s: 01780000-1009; -3000; & -1010. Access to the site is to be provided via two driveways extending southwest from Jackson Highway as shown in the site plan on Figure 2. Future development may consist of an easement through the neighboring property to the west providing access from the subject site to the Rush Road & Maurin Road intersection. Based on ITE data the project would be anticipated to generate 80 new AM peak hour trips (62 in / 18 out) and 100 new PM peak hour trips (28 in / 72 out).

Existing level of service (LOS) is summarized in Table 1 and indicates the intersections of study operating with delays of LOS C or better. For forecast analyses, a five-year horizon was evaluated to assess impacts under future conditions. Table 3 summarizes forecast 2025 PM peak hour LOS delays without and with the project. Forecast 2025 conditions are shown to operate satisfactorily with LOS D or better conditions indicating no operational deficiencies. Capacity improvements such as left turn lanes are proposed both across the subject site's frontage as well as a left turn lane on Jackson Highway at Rush Road.

Based on the analysis above, the following mitigation is recommended:

1. Construct a left-turn lane on Jackson Highway at Rush Road. Traffic volumes suggest a minimum of 125-feet of storage capacity. Final design shall be coordinated with the County for approval.
2. Construct two-way left-turn lane along the site's frontage in accordance with County standards.
3. Any transit bus pullouts along Jackson Highway shall be coordinated with Twin Transit and Lewis County for preferred location and design.

No other mitigation is identified at this time.

JACKSON HIGHWAY WAREHOUSE
TRAFFIC IMPACT ANALYSIS

COUNTS

APPENDIX

Heath & Associates

PO Box 397
Puyallup, WA 98371

File Name : 4517a
Site Code : 00004517
Start Date : 1/6/2022
Page No : 1

Groups Printed- Passenger + - Heavy

Start Time	Jackson HWY From North			Jackson HWY From South			Rush Road From West			Int. Total
	Right	Thru	App. Total	Thru	Left	App. Total	Right	Left	App. Total	
07:00 AM	9	11	20	48	22	70	0	6	6	96
07:15 AM	10	13	23	68	29	97	6	12	18	138
07:30 AM	15	16	31	55	15	70	7	19	26	127
07:45 AM	13	15	28	41	24	65	7	14	21	114
Total	47	55	102	212	90	302	20	51	71	475
08:00 AM	13	10	23	29	17	46	4	8	12	81
08:15 AM	9	18	27	35	23	58	6	7	13	98
08:30 AM	11	15	26	54	21	75	7	11	18	119
08:45 AM	7	16	23	38	15	53	10	16	26	102
Total	40	59	99	156	76	232	27	42	69	400
Grand Total	87	114	201	368	166	534	47	93	140	875
Apprch %	43.3	56.7		68.9	31.1		33.6	66.4		
Total %	9.9	13	23	42.1	19	61	5.4	10.6	16	
Passenger +	86	107	193	359	160	519	41	92	133	845
% Passenger +	98.9	93.9	96	97.6	96.4	97.2	87.2	98.9	95	96.6
Heavy	1	7	8	9	6	15	6	1	7	30
% Heavy	1.1	6.1	4	2.4	3.6	2.8	12.8	1.1	5	3.4

Heath & Associates

PO Box 397
Puyallup, WA 98371

File Name : 4517a
Site Code : 00004517
Start Date : 1/6/2022
Page No : 2

Start Time	Jackson HWY From North			Jackson HWY From South			Rush Road From West			Int. Total
	Right	Thru	App. Total	Thru	Left	App. Total	Right	Left	App. Total	
Peak Hour Analysis From 07:00 AM to 08:45 AM - Peak 1 of 1										
Peak Hour for Entire Intersection Begins at 07:00 AM										
07:00 AM	9	11	20	48	22	70	0	6	6	96
07:15 AM	10	13	23	68	29	97	6	12	18	138
07:30 AM	15	16	31	55	15	70	7	19	26	127
07:45 AM	13	15	28	41	24	65	7	14	21	114
Total Volume	47	55	102	212	90	302	20	51	71	475
% App. Total	46.1	53.9		70.2	29.8		28.2	71.8		
PHF	.783	.859	.823	.779	.776	.778	.714	.671	.683	.861
Passenger +	46	50	96	204	88	292	18	51	69	457
% Passenger +	97.9	90.9	94.1	96.2	97.8	96.7	90.0	100	97.2	96.2
Heavy	1	5	6	8	2	10	2	0	2	18
% Heavy	2.1	9.1	5.9	3.8	2.2	3.3	10.0	0	2.8	3.8

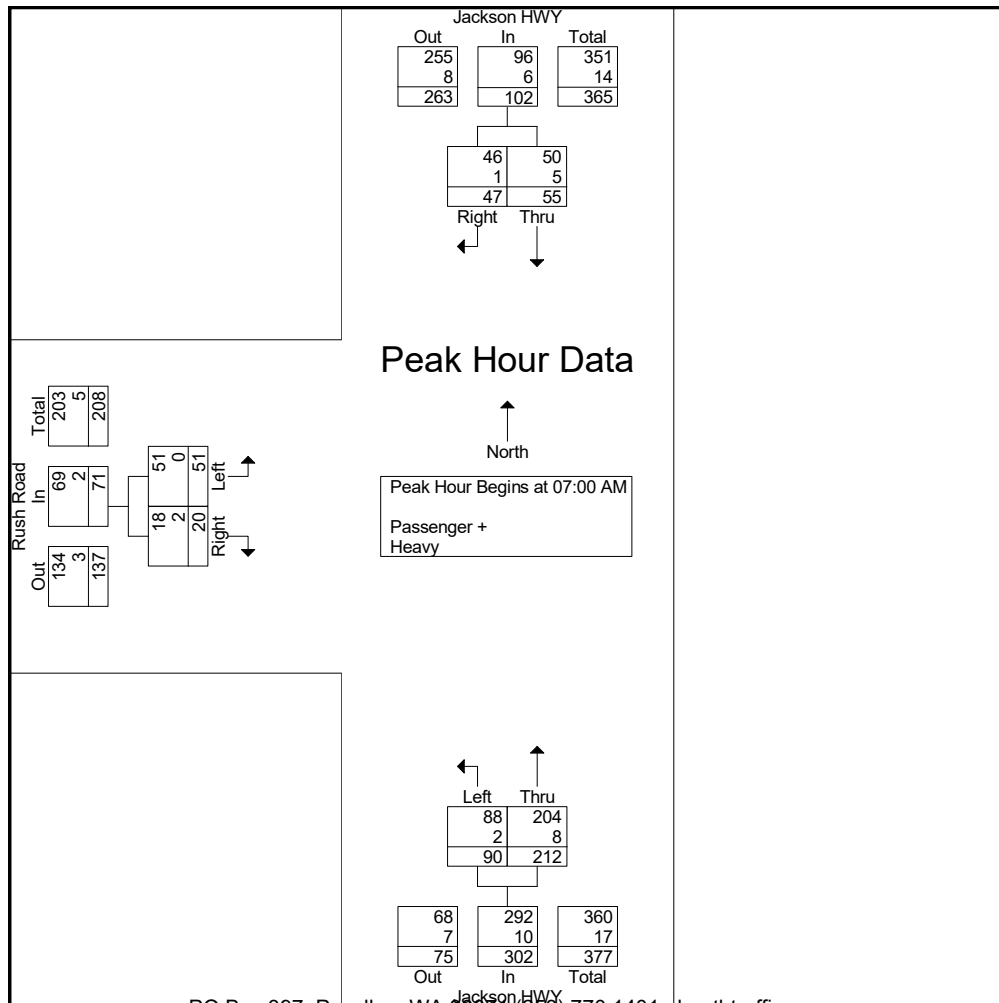

Heath & Associates

2214 Tacoma Rd E
Puyallup, WA 98371

File Name : 4517a
Site Code : 00004517
Start Date : 10/15/2020
Page No : 1

Groups Printed- Passenger - + Trucks

Start Time	SB Off-Ramp Southbound				Rush Rd Westbound				SB On-Ramp Northbound				Rush Rd Eastbound				Int. Total
	Right	Thru	Left	App. Total	Right	Thru	Left	App. Total	Right	Thru	Left	App. Total	Right	Thru	Left	App. Total	
04:00 PM	73	0	24	97	0	49	23	72	0	0	0	0	37	69	0	106	275
04:15 PM	72	0	15	87	0	61	20	81	0	0	0	0	30	67	0	97	265
04:30 PM	68	0	19	87	0	60	24	84	0	0	0	0	15	79	0	94	265
04:45 PM	81	1	29	111	0	77	22	99	0	0	0	0	40	64	0	104	314
Total	294	1	87	382	0	247	89	336	0	0	0	0	122	279	0	401	1119
05:00 PM	71	0	18	89	0	59	24	83	0	0	0	0	43	64	0	107	279
05:15 PM	83	0	29	112	0	65	18	83	0	0	0	0	34	66	0	100	295
05:30 PM	82	0	19	101	0	46	13	59	0	0	0	0	40	59	0	99	259
05:45 PM	47	0	20	67	0	45	25	70	0	0	0	0	26	61	0	87	224
Total	283	0	86	369	0	215	80	295	0	0	0	0	143	250	0	393	1057
Grand Total	577	1	173	751	0	462	169	631	0	0	0	0	265	529	0	794	2176
Apprch %	76.8	0.1	23		0	73.2	26.8		0	0	0		33.4	66.6	0		
Total %	26.5	0	8	34.5	0	21.2	7.8	29	0	0	0	0	12.2	24.3	0	36.5	
Passenger	522	1	154	677	0	394	149	543	0	0	0	0	201	465	0	666	1886
% Passenger	90.5	100	89	90.1	0	85.3	88.2	86.1	0	0	0	0	75.8	87.9	0	83.9	86.7
+ Trucks	55	0	19	74	0	68	20	88	0	0	0	0	64	64	0	128	290
% + Trucks	9.5	0	11	9.9	0	14.7	11.8	13.9	0	0	0	0	24.2	12.1	0	16.1	13.3

Heath & Associates

2214 Tacoma Rd E
Puyallup, WA 98371

File Name : 4517a
Site Code : 00004517
Start Date : 10/15/2020
Page No : 2

Start Time	SB Off-Ramp Southbound				Rush Rd Westbound				SB On-Ramp Northbound				Rush Rd Eastbound				Int. Total
	Right	Thru	Left	App. Total	Right	Thru	Left	App. Total	Right	Thru	Left	App. Total	Right	Thru	Left	App. Total	
Peak Hour Analysis From 04:00 PM to 05:45 PM - Peak 1 of 1																	
Peak Hour for Entire Intersection Begins at 04:30 PM																	
04:30 PM	68	0	19	87	0	60	24	84	0	0	0	0	15	79	0	94	265
04:45 PM	81	1	29	111	0	77	22	99	0	0	0	0	40	64	0	104	314
05:00 PM	71	0	18	89	0	59	24	83	0	0	0	0	43	64	0	107	279
05:15 PM	83	0	29	112	0	65	18	83	0	0	0	0	34	66	0	100	295
Total Volume	303	1	95	399	0	261	88	349	0	0	0	0	132	273	0	405	1153
% App. Total	75.9	0.3	23.8		0	74.8	25.2		0	0	0		32.6	67.4	0		
PHF	.913	.250	.819	.891	.000	.847	.917	.881	.000	.000	.000	.000	.767	.864	.000	.946	.918
Passenger	271	1	83	355	0	228	74	302	0	0	0	0	103	242	0	345	1002
% Passenger	89.4	100	87.4	89.0	0	87.4	84.1	86.5	0	0	0	0	78.0	88.6	0	85.2	86.9
+ Trucks	32	0	12	44	0	33	14	47	0	0	0	0	29	31	0	60	151
% + Trucks	10.6	0	12.6	11.0	0	12.6	15.9	13.5	0	0	0	0	22.0	11.4	0	14.8	13.1

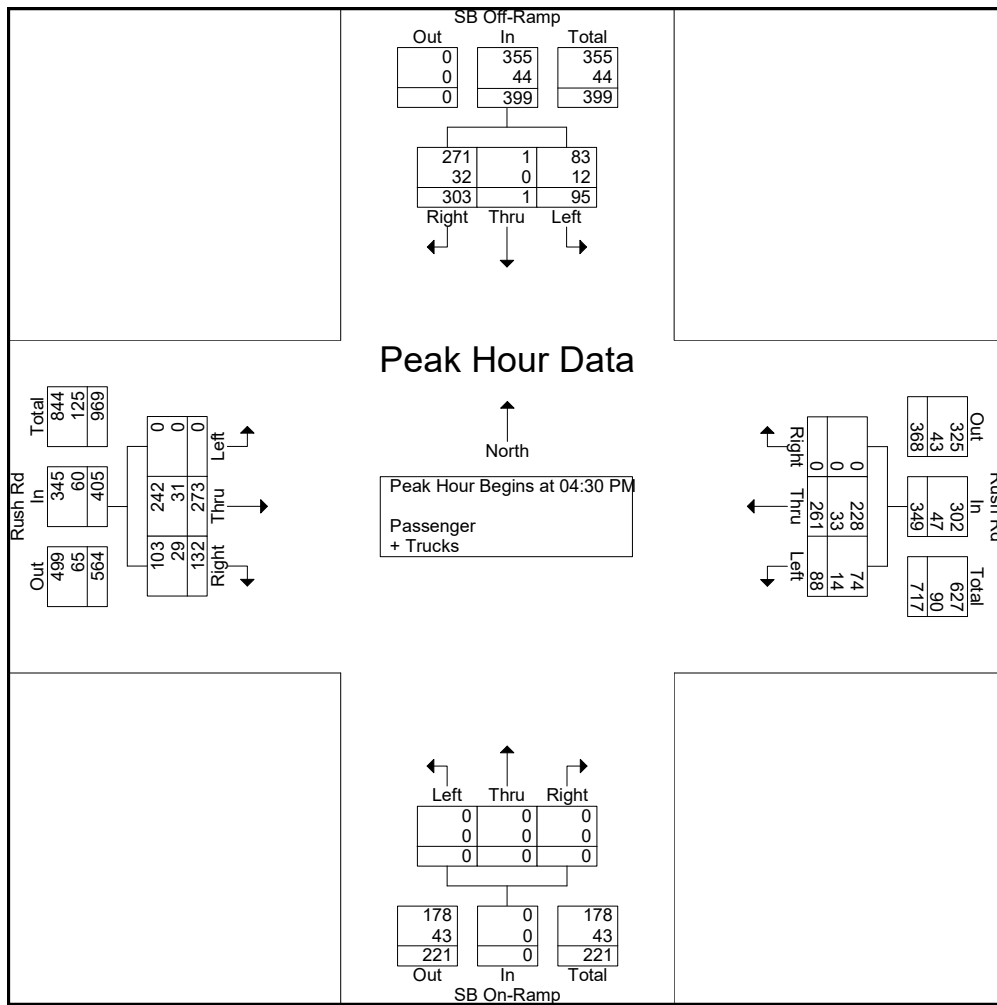

Heath & Associates

2214 Tacoma Rd E
Puyallup, WA 98371

File Name : 4517b
Site Code : 00004517
Start Date : 10/15/2020
Page No : 1

Groups Printed- Passenger - + Trucks

Start Time	NB On-Ramp Southbound				Rush Rd Westbound				NB Off-Ramp Northbound				Rush Rd Eastbound				Int. Total
	Right	Thru	Left	App. Total	Right	Thru	Left	App. Total	Right	Thru	Left	App. Total	Right	Thru	Left	App. Total	
04:00 PM	0	0	0	0	22	53	0	75	19	1	21	41	0	40	55	95	211
04:15 PM	0	0	0	0	21	59	0	80	19	0	20	39	0	45	41	86	205
04:30 PM	0	0	0	0	28	67	0	95	27	0	22	49	0	45	52	97	241
04:45 PM	0	0	0	0	30	58	0	88	23	0	35	58	0	57	37	94	240
Total	0	0	0	0	101	237	0	338	88	1	98	187	0	187	185	372	897
05:00 PM	0	0	0	0	31	71	0	102	28	0	17	45	0	38	42	80	227
05:15 PM	0	0	0	0	27	51	0	78	31	0	27	58	0	62	40	102	238
05:30 PM	0	0	0	0	21	30	0	51	18	0	25	43	0	33	40	73	167
05:45 PM	0	0	0	0	17	57	0	74	25	1	18	44	0	37	44	81	199
Total	0	0	0	0	96	209	0	305	102	1	87	190	0	170	166	336	831
Grand Total	0	0	0	0	197	446	0	643	190	2	185	377	0	357	351	708	1728
Apprch %	0	0	0	0	30.6	69.4	0		50.4	0.5	49.1		0	50.4	49.6		
Total %	0	0	0	0	11.4	25.8	0	37.2	11	0.1	10.7	21.8	0	20.7	20.3	41	
Passenger	0	0	0	0	180	419	0	599	170	1	124	295	0	334	297	631	1525
% Passenger	0	0	0	0	91.4	93.9	0	93.2	89.5	50	67	78.2	0	93.6	84.6	89.1	88.3
+ Trucks	0	0	0	0	17	27	0	44	20	1	61	82	0	23	54	77	203
% + Trucks	0	0	0	0	8.6	6.1	0	6.8	10.5	50	33	21.8	0	6.4	15.4	10.9	11.7

Heath & Associates

2214 Tacoma Rd E
Puyallup, WA 98371

File Name : 4517b
Site Code : 00004517
Start Date : 10/15/2020
Page No : 2

Start Time	NB On-Ramp Southbound				Rush Rd Westbound				NB Off-Ramp Northbound				Rush Rd Eastbound				Int. Total
	Right	Thru	Left	App. Total	Right	Thru	Left	App. Total	Right	Thru	Left	App. Total	Right	Thru	Left	App. Total	
Peak Hour Analysis From 04:00 PM to 05:45 PM - Peak 1 of 1																	
Peak Hour for Entire Intersection Begins at 04:30 PM																	
04:30 PM	0	0	0	0	28	67	0	95	27	0	22	49	0	45	52	97	241
04:45 PM	0	0	0	0	30	58	0	88	23	0	35	58	0	57	37	94	240
05:00 PM	0	0	0	0	31	71	0	102	28	0	17	45	0	38	42	80	227
05:15 PM	0	0	0	0	27	51	0	78	31	0	27	58	0	62	40	102	238
Total Volume	0	0	0	0	116	247	0	363	109	0	101	210	0	202	171	373	946
% App. Total	0	0	0	0	32	68	0	92.3	51.9	0	48.1	81.4	0	54.2	45.8	88.7	88.5
PHF	.000	.000	.000	.000	.935	.870	.000	.890	.879	.000	.721	.905	.000	.815	.822	.914	.981
Passenger	0	0	0	0	106	229	0	335	98	0	73	171	0	187	144	331	837
% Passenger + Trucks	0	0	0	0	91.4	92.7	0	92.3	89.9	0	72.3	81.4	0	92.6	84.2	88.7	88.5
+ Trucks	0	0	0	0	10	18	0	28	11	0	28	39	0	15	27	42	109
% + Trucks	0	0	0	0	8.6	7.3	0	7.7	10.1	0	27.7	18.6	0	7.4	15.8	11.3	11.5

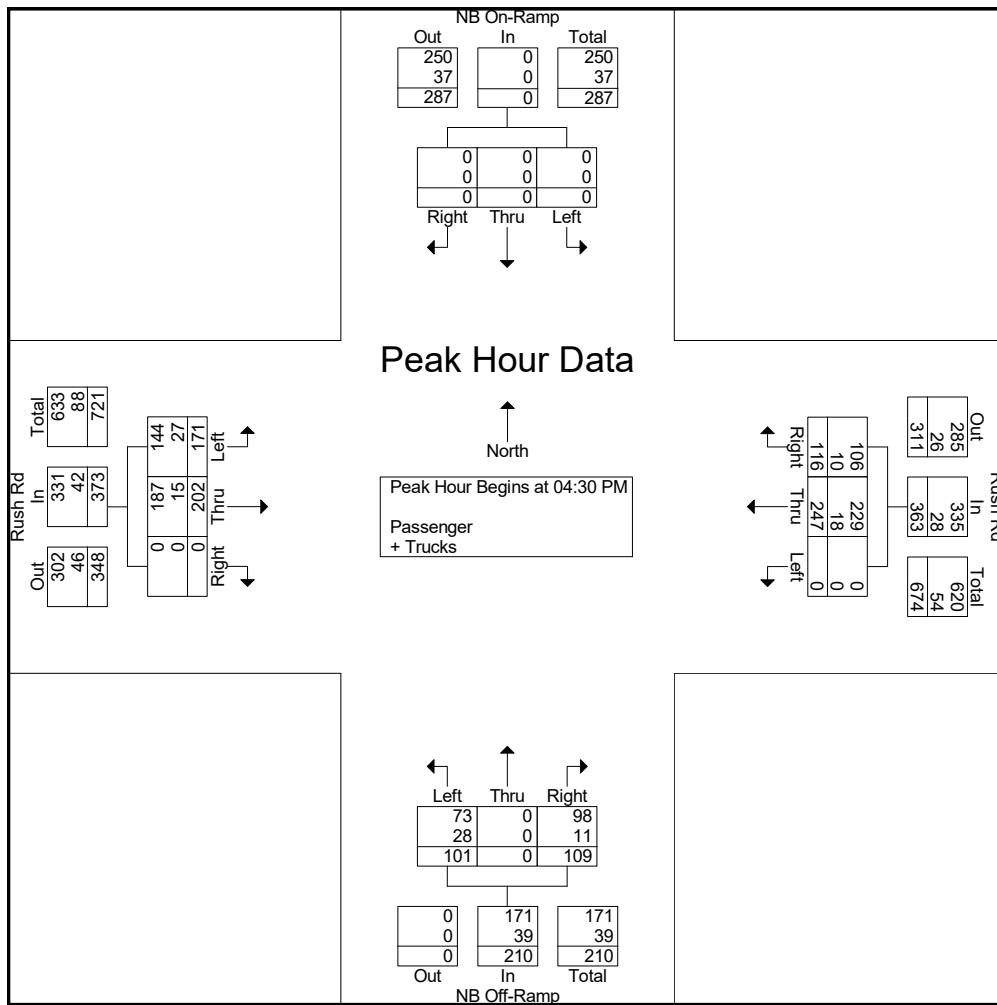

Heath & Associates

2214 Tacoma Rd E
Puyallup, WA 98371

File Name : 4517c
Site Code : 00004517
Start Date : 10/15/2020
Page No : 1

Groups Printed- Passenger - + Trucks

Start Time	Rush Rd Southbound			Kirkland Rd Northbound			Rush Rd Eastbound			Int. Total
	Right	Thru	App. Total	Thru	Left	App. Total	Right	Left	App. Total	
04:00 PM	50	12	62	12	25	37	27	33	60	159
04:15 PM	55	7	62	9	25	34	20	46	66	162
04:30 PM	73	15	88	9	20	29	30	41	71	188
04:45 PM	55	15	70	12	31	43	35	45	80	193
Total	233	49	282	42	101	143	112	165	277	702
05:00 PM	75	7	82	9	27	36	26	38	64	182
05:15 PM	44	11	55	3	32	35	37	56	93	183
05:30 PM	27	12	39	9	23	32	29	23	52	123
05:45 PM	47	11	58	11	28	39	32	31	63	160
Total	193	41	234	32	110	142	124	148	272	648
Grand Total	426	90	516	74	211	285	236	313	549	1350
Apprch %	82.6	17.4		26	74		43	57		
Total %	31.6	6.7	38.2	5.5	15.6	21.1	17.5	23.2	40.7	
Passenger	393	87	480	72	202	274	228	278	506	1260
% Passenger	92.3	96.7	93	97.3	95.7	96.1	96.6	88.8	92.2	93.3
+ Trucks	33	3	36	2	9	11	8	35	43	90
% + Trucks	7.7	3.3	7	2.7	4.3	3.9	3.4	11.2	7.8	6.7

Heath & Associates

2214 Tacoma Rd E
Puyallup, WA 98371

File Name : 4517c
Site Code : 00004517
Start Date : 10/15/2020
Page No : 2

Start Time	Rush Rd Southbound			Kirkland Rd Northbound			Rush Rd Eastbound			Int. Total
	Right	Thru	App. Total	Thru	Left	App. Total	Right	Left	App. Total	
Peak Hour Analysis From 04:00 PM to 05:45 PM - Peak 1 of 1										
Peak Hour for Entire Intersection Begins at 04:30 PM										
04:30 PM	73	15	88	9	20	29	30	41	71	188
04:45 PM	55	15	70	12	31	43	35	45	80	193
05:00 PM	75	7	82	9	27	36	26	38	64	182
05:15 PM	44	11	55	3	32	35	37	56	93	183
Total Volume	247	48	295	33	110	143	128	180	308	746
% App. Total	83.7	16.3		23.1	76.9		41.6	58.4		
PHF	.823	.800	.838	.688	.859	.831	.865	.804	.828	.966
Passenger	222	46	268	33	108	141	124	158	282	691
% Passenger	89.9	95.8	90.8	100	98.2	98.6	96.9	87.8	91.6	92.6
+ Trucks	25	2	27	0	2	2	4	22	26	55
% + Trucks	10.1	4.2	9.2	0	1.8	1.4	3.1	12.2	8.4	7.4

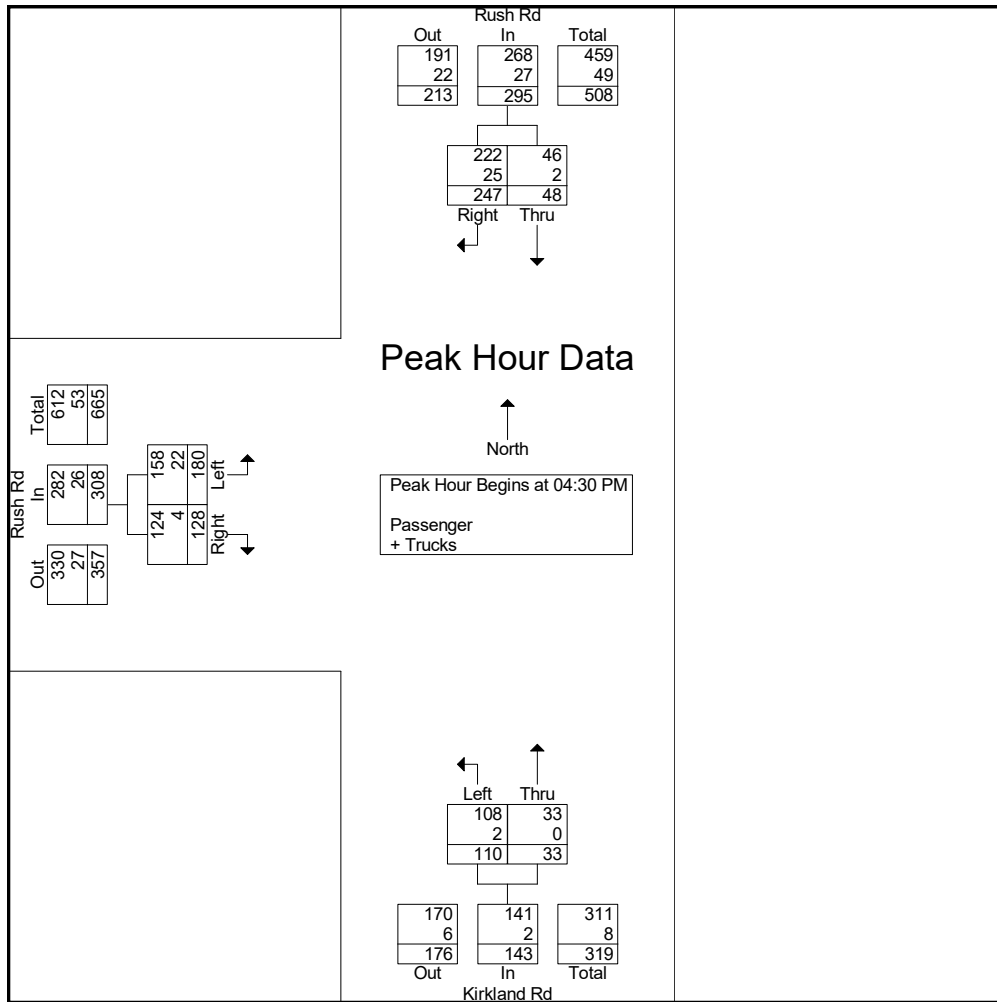

Heath & Associates

2214 Tacoma Rd E
Puyallup, WA 98371

File Name : 4517d
Site Code : 00004517
Start Date : 10/15/2020
Page No : 1

Groups Printed- Passenger - + Trucks

Start Time	Rush Rd Southbound				Bishop Rd Westbound				Rush Rd Northbound				Bishop Rd Eastbound				Int. Total
	Right	Thru	Left	App. Total	Right	Thru	Left	App. Total	Right	Thru	Left	App. Total	Right	Thru	Left	App. Total	
04:00 PM	0	22	0	22	0	15	10	25	5	19	5	29	16	13	0	29	105
04:15 PM	0	24	0	24	1	8	3	12	10	17	3	30	19	19	1	39	105
04:30 PM	1	35	1	37	0	7	11	18	10	19	4	33	19	10	0	29	117
04:45 PM	3	19	1	23	1	6	13	20	6	24	8	38	20	15	1	36	117
Total	4	100	2	106	2	36	37	75	31	79	20	130	74	57	2	133	444
05:00 PM	0	24	2	26	1	10	6	17	10	9	3	22	28	12	0	40	105
05:15 PM	0	18	3	21	0	11	9	20	11	19	4	34	14	12	1	27	102
05:30 PM	0	13	0	13	0	1	6	7	7	6	2	15	7	12	0	19	54
05:45 PM	0	21	0	21	0	3	12	15	8	14	2	24	7	4	1	12	72
Total	0	76	5	81	1	25	33	59	36	48	11	95	56	40	2	98	333
Grand Total	4	176	7	187	3	61	70	134	67	127	31	225	130	97	4	231	777
Apprch %	2.1	94.1	3.7		2.2	45.5	52.2		29.8	56.4	13.8		56.3	42	1.7		
Total %	0.5	22.7	0.9	24.1	0.4	7.9	9	17.2	8.6	16.3	4	29	16.7	12.5	0.5	29.7	
Passenger	4	174	6	184	3	60	67	130	66	123	30	219	121	94	4	219	752
% Passenger	100	98.9	85.7	98.4	100	98.4	95.7	97	98.5	96.9	96.8	97.3	93.1	96.9	100	94.8	96.8
+ Trucks	0	2	1	3	0	1	3	4	1	4	1	6	9	3	0	12	25
% + Trucks	0	1.1	14.3	1.6	0	1.6	4.3	3	1.5	3.1	3.2	2.7	6.9	3.1	0	5.2	3.2

Heath & Associates

2214 Tacoma Rd E
Puyallup, WA 98371

File Name : 4517d
Site Code : 00004517
Start Date : 10/15/2020
Page No : 2

Start Time	Rush Rd Southbound				Bishop Rd Westbound				Rush Rd Northbound				Bishop Rd Eastbound				Int. Total
	Right	Thru	Left	App. Total	Right	Thru	Left	App. Total	Right	Thru	Left	App. Total	Right	Thru	Left	App. Total	
Peak Hour Analysis From 04:00 PM to 05:45 PM - Peak 1 of 1																	
Peak Hour for Entire Intersection Begins at 04:00 PM																	
04:00 PM	0	22	0	22	0	15	10	25	5	19	5	29	16	13	0	29	105
04:15 PM	0	24	0	24	1	8	3	12	10	17	3	30	19	19	1	39	105
04:30 PM	1	35	1	37	0	7	11	18	10	19	4	33	19	10	0	29	117
04:45 PM	3	19	1	23	1	6	13	20	6	24	8	38	20	15	1	36	117
Total Volume	4	100	2	106	2	36	37	75	31	79	20	130	74	57	2	133	444
% App. Total	3.8	94.3	1.9		2.7	48	49.3		23.8	60.8	15.4		55.6	42.9	1.5		
PHF	.333	.714	.500	.716	.500	.600	.712	.750	.775	.823	.625	.855	.925	.750	.500	.853	.949
Passenger	4	100	2	106	2	36	36	74	30	75	19	124	69	55	2	126	430
% Passenger	100	100	100	100	100	100	97.3	98.7	96.8	94.9	95.0	95.4	93.2	96.5	100	94.7	96.8
+ Trucks	0	0	0	0	0	0	1	1	1	4	1	6	5	2	0	7	14
% + Trucks	0	0	0	0	0	0	2.7	1.3	3.2	5.1	5.0	4.6	6.8	3.5	0	5.3	3.2

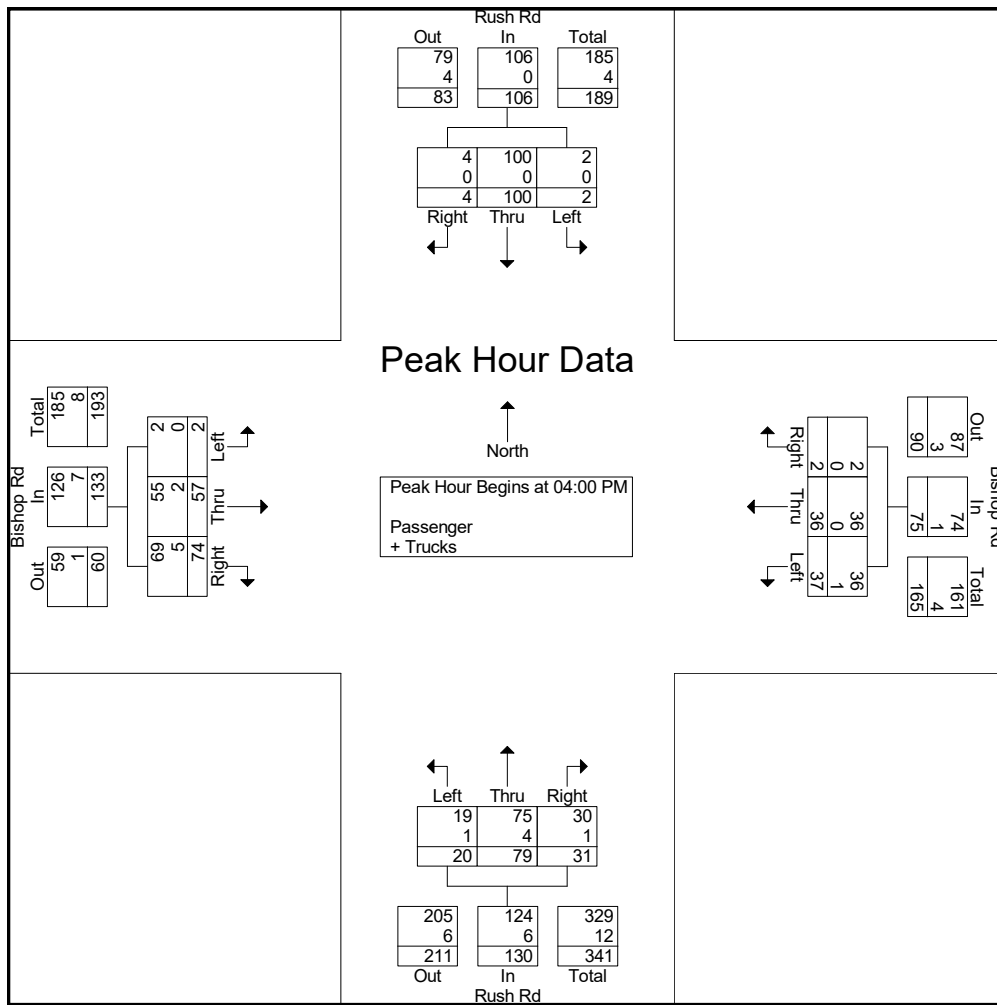

Heath & Associates

2214 Tacoma Rd E
Puyallup, WA 98371

File Name : 4517e
Site Code : 00004517
Start Date : 10/15/2020
Page No : 1

Groups Printed- Passenger - + Trucks

Start Time	Rush Rd Southbound			Rush Rd Northbound			Maurin Rd Eastbound			Int. Total
	Right	Thru	App. Total	Thru	Left	App. Total	Right	Left	App. Total	
04:00 PM	11	17	28	16	6	22	3	33	36	86
04:15 PM	16	25	41	10	7	17	4	30	34	92
04:30 PM	16	22	38	13	7	20	14	29	43	101
04:45 PM	23	13	36	16	11	27	6	23	29	92
Total	66	77	143	55	31	86	27	115	142	371
05:00 PM	13	23	36	8	2	10	7	31	38	84
05:15 PM	16	17	33	17	1	18	3	26	29	80
05:30 PM	15	14	29	4	2	6	1	21	22	57
05:45 PM	11	19	30	16	0	16	0	16	16	62
Total	55	73	128	45	5	50	11	94	105	283
Grand Total	121	150	271	100	36	136	38	209	247	654
Apprch %	44.6	55.4		73.5	26.5		15.4	84.6		
Total %	18.5	22.9	41.4	15.3	5.5	20.8	5.8	32	37.8	
Passenger	116	149	265	99	33	132	36	199	235	632
% Passenger	95.9	99.3	97.8	99	91.7	97.1	94.7	95.2	95.1	96.6
+ Trucks	5	1	6	1	3	4	2	10	12	22
% + Trucks	4.1	0.7	2.2	1	8.3	2.9	5.3	4.8	4.9	3.4

Heath & Associates

2214 Tacoma Rd E
Puyallup, WA 98371

File Name : 4517e
Site Code : 00004517
Start Date : 10/15/2020
Page No : 2

Start Time	Rush Rd Southbound			Rush Rd Northbound			Maurin Rd Eastbound			Int. Total
	Right	Thru	App. Total	Thru	Left	App. Total	Right	Left	App. Total	
Peak Hour Analysis From 04:00 PM to 05:45 PM - Peak 1 of 1										
Peak Hour for Entire Intersection Begins at 04:00 PM										
04:00 PM	11	17	28	16	6	22	3	33	36	86
04:15 PM	16	25	41	10	7	17	4	30	34	92
04:30 PM	16	22	38	13	7	20	14	29	43	101
04:45 PM	23	13	36	16	11	27	6	23	29	92
Total Volume	66	77	143	55	31	86	27	115	142	371
% App. Total	46.2	53.8		64	36		19	81		
PHF	.717	.770	.872	.859	.705	.796	.482	.871	.826	.918
Passenger	62	77	139	54	28	82	27	112	139	360
% Passenger	93.9	100	97.2	98.2	90.3	95.3	100	97.4	97.9	97.0
+ Trucks	4	0	4	1	3	4	0	3	3	11
% + Trucks	6.1	0	2.8	1.8	9.7	4.7	0	2.6	2.1	3.0

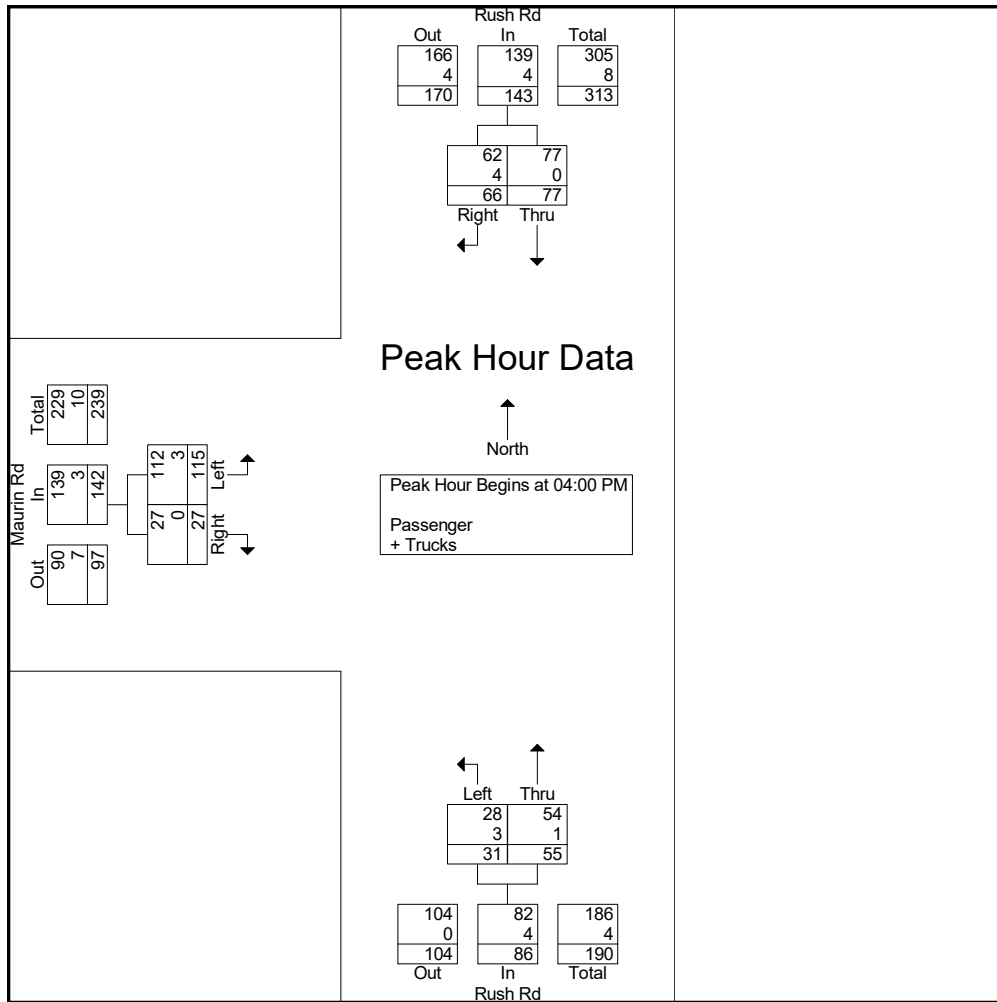

Heath & Associates

2214 Tacoma Rd E
Puyallup, WA 98371

File Name : 4517f
Site Code : 00004517
Start Date : 10/15/2020
Page No : 1

Groups Printed- Passenger - + Trucks

Start Time	Jackson Hwy Westbound			Rush Rd Northbound			Jackson Hwy Eastbound			Int. Total
	Thru	Left	App. Total	Right	Left	App. Total	Right	Thru	App. Total	
04:00 PM	41	9	50	22	22	44	22	56	78	172
04:15 PM	34	14	48	23	18	41	23	65	88	177
04:30 PM	42	13	55	22	20	42	26	64	90	187
04:45 PM	27	13	40	20	21	41	23	75	98	179
Total	144	49	193	87	81	168	94	260	354	715
05:00 PM	30	8	38	24	17	41	27	75	102	181
05:15 PM	27	15	42	21	21	42	18	68	86	170
05:30 PM	21	16	37	12	14	26	12	61	73	136
05:45 PM	33	12	45	14	14	28	16	34	50	123
Total	111	51	162	71	66	137	73	238	311	610
Grand Total	255	100	355	158	147	305	167	498	665	1325
Apprch %	71.8	28.2		51.8	48.2		25.1	74.9		
Total %	19.2	7.5	26.8	11.9	11.1	23	12.6	37.6	50.2	
Passenger	250	94	344	154	139	293	166	497	663	1300
% Passenger	98	94	96.9	97.5	94.6	96.1	99.4	99.8	99.7	98.1
+ Trucks	5	6	11	4	8	12	1	1	2	25
% + Trucks	2	6	3.1	2.5	5.4	3.9	0.6	0.2	0.3	1.9

Heath & Associates

2214 Tacoma Rd E
Puyallup, WA 98371

File Name : 4517f
Site Code : 00004517
Start Date : 10/15/2020
Page No : 2

Start Time	Jackson Hwy Westbound			Rush Rd Northbound			Jackson Hwy Eastbound			Int. Total
	Thru	Left	App. Total	Right	Left	App. Total	Right	Thru	App. Total	
Peak Hour Analysis From 04:00 PM to 05:45 PM - Peak 1 of 1										
Peak Hour for Entire Intersection Begins at 04:15 PM										
04:15 PM	34	14	48	23	18	41	23	65	88	177
04:30 PM	42	13	55	22	20	42	26	64	90	187
04:45 PM	27	13	40	20	21	41	23	75	98	179
05:00 PM	30	8	38	24	17	41	27	75	102	181
Total Volume	133	48	181	89	76	165	99	279	378	724
% App. Total	73.5	26.5		53.9	46.1		26.2	73.8		
PHF	.792	.857	.823	.927	.905	.982	.917	.930	.926	.968
Passenger	131	45	176	86	73	159	99	278	377	712
% Passenger	98.5	93.8	97.2	96.6	96.1	96.4	100	99.6	99.7	98.3
+ Trucks	2	3	5	3	3	6	0	1	1	12
% + Trucks	1.5	6.3	2.8	3.4	3.9	3.6	0	0.4	0.3	1.7

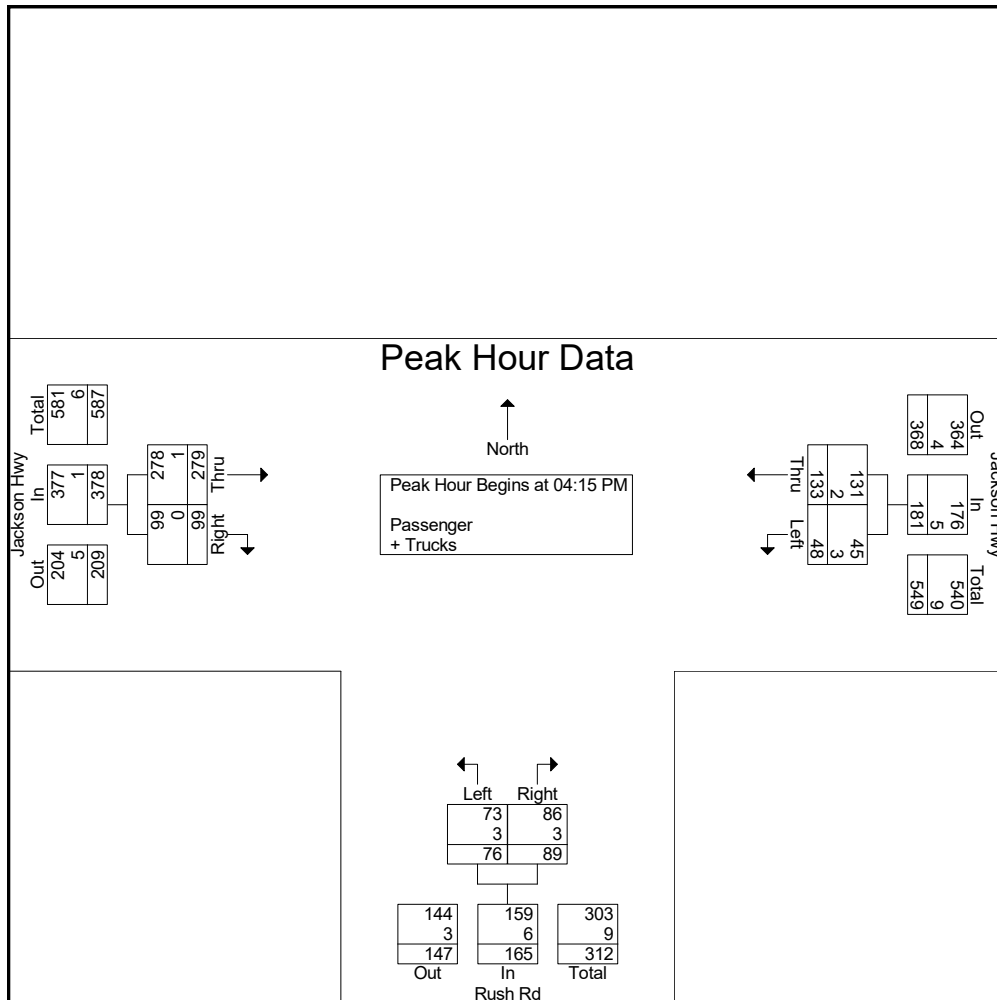

Heath & Associates

2214 Tacoma Rd E
Puyallup, WA 98371

File Name : 4517g
Site Code : 00004517
Start Date : 10/15/2020
Page No : 1

Groups Printed- Passenger - + Trucks

Start Time	NB On-Ramp Southbound				Labree Rd Westbound				NB Off-Ramp Northbound				Labree Rd Eastbound				Int. Total
	Right	Thru	Left	App. Total	Right	Thru	Left	App. Total	Right	Thru	Left	App. Total	Right	Thru	Left	App. Total	
04:00 PM	0	0	0	0	34	52	0	86	20	1	4	25	0	62	17	79	190
04:15 PM	0	0	0	0	37	59	0	96	13	0	3	16	0	61	22	83	195
04:30 PM	0	0	0	0	56	86	0	142	11	0	2	13	0	71	16	87	242
04:45 PM	0	0	0	0	39	39	0	78	9	0	3	12	0	82	28	110	200
Total	0	0	0	0	166	236	0	402	53	1	12	66	0	276	83	359	827
05:00 PM	0	0	0	0	30	66	0	96	17	0	4	21	0	52	33	85	202
05:15 PM	0	0	0	0	31	69	0	100	17	0	4	21	0	56	27	83	204
05:30 PM	0	0	0	0	22	45	0	67	16	2	0	18	0	41	34	75	160
05:45 PM	0	0	0	0	12	29	0	41	19	0	1	20	0	34	16	50	111
Total	0	0	0	0	95	209	0	304	69	2	9	80	0	183	110	293	677
Grand Total	0	0	0	0	261	445	0	706	122	3	21	146	0	459	193	652	1504
Apprch %	0	0	0	0	37	63	0		83.6	2.1	14.4		0	70.4	29.6		
Total %	0	0	0	0	17.4	29.6	0	46.9	8.1	0.2	1.4	9.7	0	30.5	12.8	43.4	
Passenger	0	0	0	0	236	415	0	651	90	2	18	110	0	423	184	607	1368
% Passenger	0	0	0	0	90.4	93.3	0	92.2	73.8	66.7	85.7	75.3	0	92.2	95.3	93.1	91
+ Trucks	0	0	0	0	25	30	0	55	32	1	3	36	0	36	9	45	136
% + Trucks	0	0	0	0	9.6	6.7	0	7.8	26.2	33.3	14.3	24.7	0	7.8	4.7	6.9	9

Heath & Associates

2214 Tacoma Rd E
Puyallup, WA 98371

File Name : 4517g
Site Code : 00004517
Start Date : 10/15/2020
Page No : 2

Start Time	NB On-Ramp Southbound				Labree Rd Westbound				NB Off-Ramp Northbound				Labree Rd Eastbound				Int. Total
	Right	Thru	Left	App. Total	Right	Thru	Left	App. Total	Right	Thru	Left	App. Total	Right	Thru	Left	App. Total	
Peak Hour Analysis From 04:00 PM to 05:45 PM - Peak 1 of 1																	
Peak Hour for Entire Intersection Begins at 04:30 PM																	
04:30 PM	0	0	0	0	56	86	0	142	11	0	2	13	0	71	16	87	242
04:45 PM	0	0	0	0	39	39	0	78	9	0	3	12	0	82	28	110	200
05:00 PM	0	0	0	0	30	66	0	96	17	0	4	21	0	52	33	85	202
05:15 PM	0	0	0	0	31	69	0	100	17	0	4	21	0	56	27	83	204
Total Volume	0	0	0	0	156	260	0	416	54	0	13	67	0	261	104	365	848
% App. Total	0	0	0	0	37.5	62.5	0		80.6	0	19.4		0	71.5	28.5		
PHF	.000	.000	.000	.000	.696	.756	.000	.732	.794	.000	.813	.798	.000	.796	.788	.830	.876
Passenger	0	0	0	0	146	239	0	385	41	0	11	52	0	243	101	344	781
% Passenger	0	0	0	0	93.6	91.9	0	92.5	75.9	0	84.6	77.6	0	93.1	97.1	94.2	92.1
+ Trucks	0	0	0	0	10	21	0	31	13	0	2	15	0	18	3	21	67
% + Trucks	0	0	0	0	6.4	8.1	0	7.5	24.1	0	15.4	22.4	0	6.9	2.9	5.8	7.9

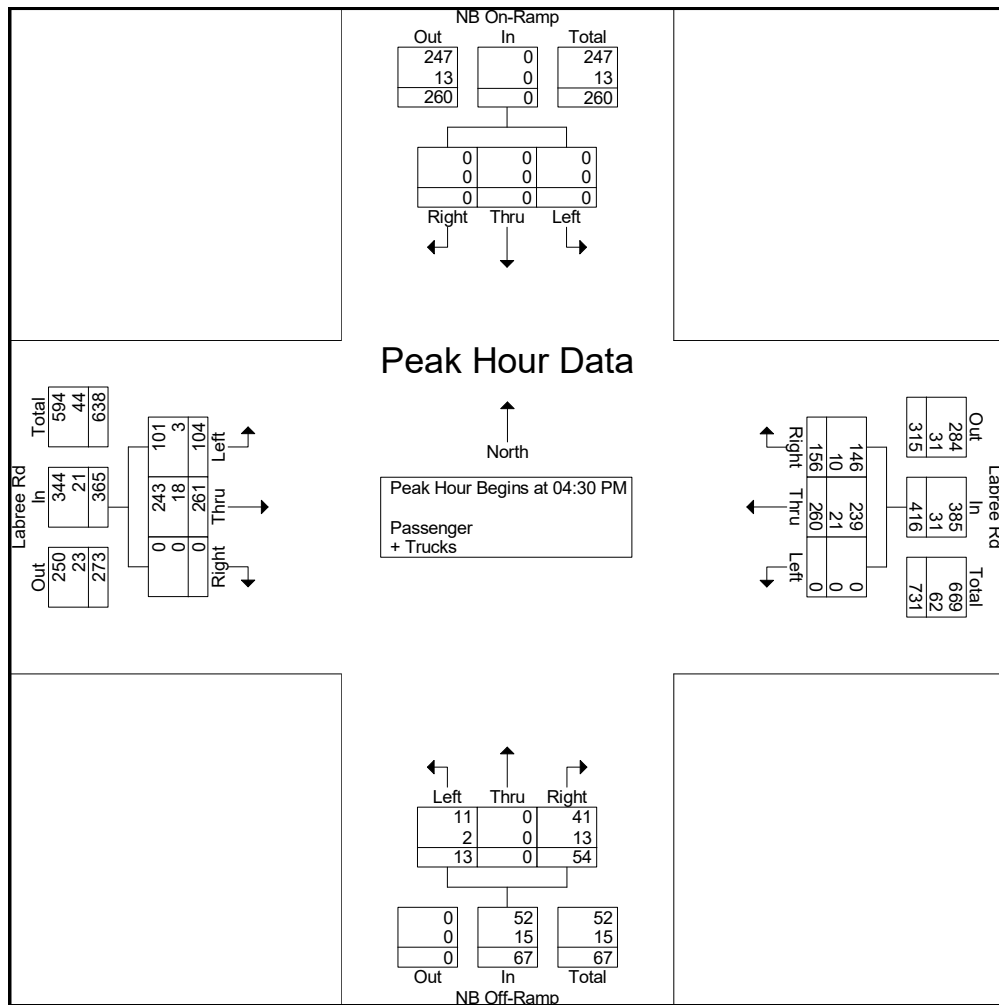

Heath & Associates

2214 Tacoma Rd E
Puyallup, WA 98371

File Name : 4517h
Site Code : 00004517
Start Date : 10/15/2020
Page No : 1

Groups Printed- Passenger - + Trucks

Start Time	SB Off-Ramp Southbound				Labree Rd Westbound				SB On-Ramp Northbound				Labree Rd Eastbound				Int. Total
	Right	Thru	Left	App. Total	Right	Thru	Left	App. Total	Right	Thru	Left	App. Total	Right	Thru	Left	App. Total	
04:00 PM	6	0	59	65	0	10	51	61	0	0	0	0	5	16	0	21	147
04:15 PM	10	0	67	77	0	17	35	52	0	0	0	0	3	21	0	24	153
04:30 PM	8	1	65	74	0	20	67	87	0	0	0	0	3	11	0	14	175
04:45 PM	9	1	84	94	0	11	34	45	0	0	0	0	2	24	0	26	165
Total	33	2	275	310	0	58	187	245	0	0	0	0	13	72	0	85	640
05:00 PM	8	0	54	62	0	23	45	68	0	0	0	0	4	37	0	41	171
05:15 PM	13	0	60	73	0	26	47	73	0	0	0	0	1	21	0	22	168
05:30 PM	11	0	60	71	0	7	40	47	0	0	0	0	2	23	0	25	143
05:45 PM	7	1	36	44	0	12	19	31	0	0	0	0	2	14	0	16	91
Total	39	1	210	250	0	68	151	219	0	0	0	0	9	95	0	104	573
Grand Total	72	3	485	560	0	126	338	464	0	0	0	0	22	167	0	189	1213
Apprch %	12.9	0.5	86.6		0	27.2	72.8		0	0	0		11.6	88.4	0		
Total %	5.9	0.2	40	46.2	0	10.4	27.9	38.3	0	0	0	0	1.8	13.8	0	15.6	
Passenger	63	3	451	517	0	122	312	434	0	0	0	0	20	156	0	176	1127
% Passenger	87.5	100	93	92.3	0	96.8	92.3	93.5	0	0	0	0	90.9	93.4	0	93.1	92.9
+ Trucks	9	0	34	43	0	4	26	30	0	0	0	0	2	11	0	13	86
% + Trucks	12.5	0	7	7.7	0	3.2	7.7	6.5	0	0	0	0	9.1	6.6	0	6.9	7.1

Heath & Associates

2214 Tacoma Rd E
Puyallup, WA 98371

File Name : 4517h
Site Code : 00004517
Start Date : 10/15/2020
Page No : 2

Start Time	SB Off-Ramp Southbound				Labree Rd Westbound				SB On-Ramp Northbound				Labree Rd Eastbound				Int. Total
	Right	Thru	Left	App. Total	Right	Thru	Left	App. Total	Right	Thru	Left	App. Total	Right	Thru	Left	App. Total	
Peak Hour Analysis From 04:00 PM to 05:45 PM - Peak 1 of 1																	
Peak Hour for Entire Intersection Begins at 04:30 PM																	
04:30 PM	8	1	65	74	0	20	67	87	0	0	0	0	3	11	0	14	175
04:45 PM	9	1	84	94	0	11	34	45	0	0	0	0	2	24	0	26	165
05:00 PM	8	0	54	62	0	23	45	68	0	0	0	0	4	37	0	41	171
05:15 PM	13	0	60	73	0	26	47	73	0	0	0	0	1	21	0	22	168
Total Volume	38	2	263	303	0	80	193	273	0	0	0	0	10	93	0	103	679
% App. Total	12.5	0.7	86.8		0	29.3	70.7		0	0	0		9.7	90.3	0		
PHF	.731	.500	.783	.806	.000	.769	.720	.784	.000	.000	.000	.000	.625	.628	.000	.628	.970
Passenger	34	2	246	282	0	78	173	251	0	0	0	0	10	90	0	100	633
% Passenger	89.5	100	93.5	93.1	0	97.5	89.6	91.9	0	0	0	0	100	96.8	0	97.1	93.2
+ Trucks	4	0	17	21	0	2	20	22	0	0	0	0	0	3	0	3	46
% + Trucks	10.5	0	6.5	6.9	0	2.5	10.4	8.1	0	0	0	0	0	3.2	0	2.9	6.8

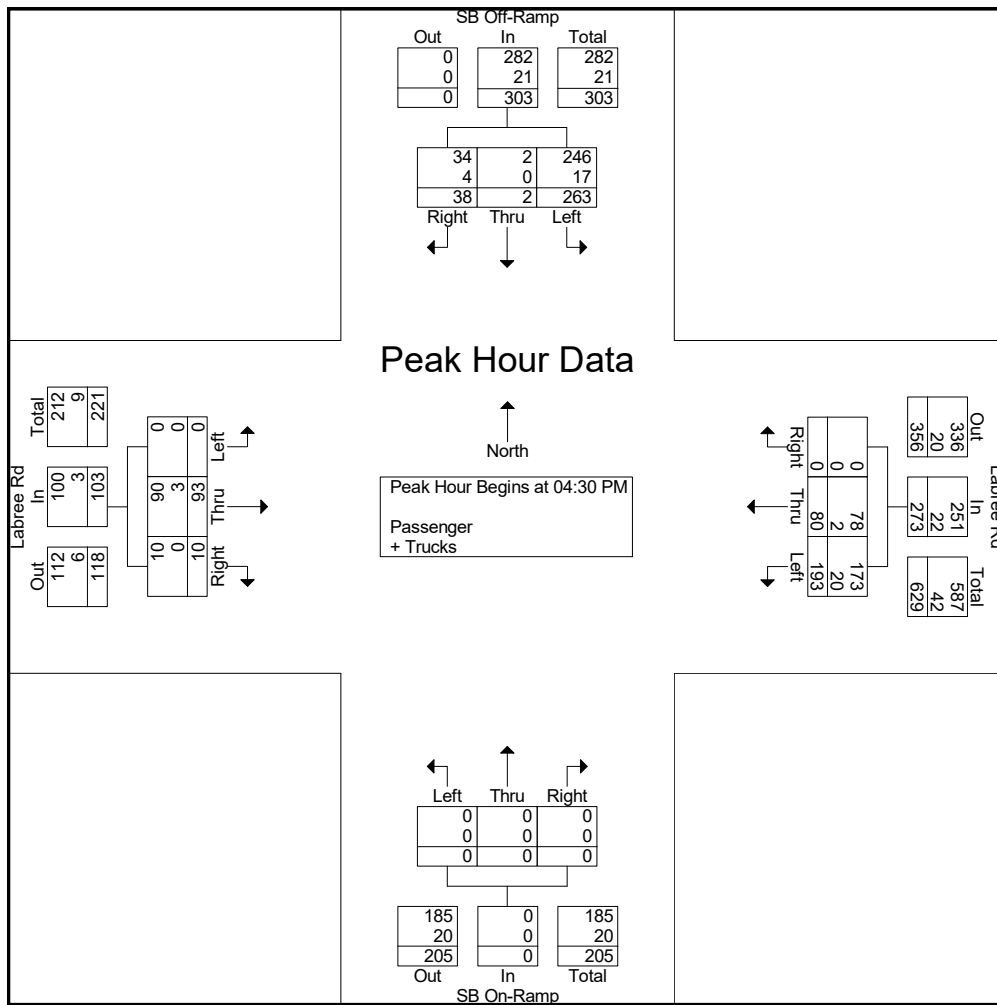

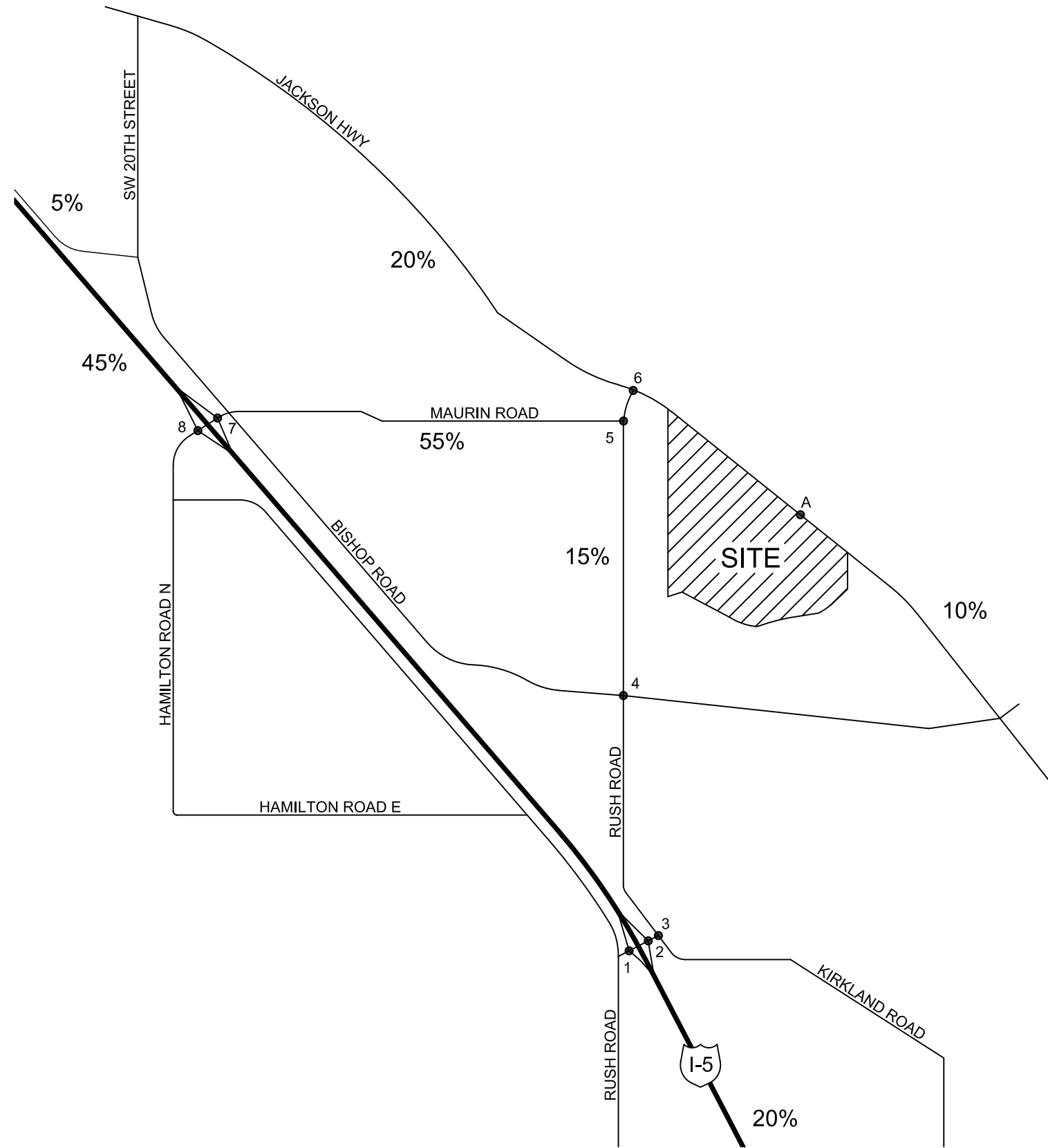

① RUSH RD & I-5 SB RAMPS

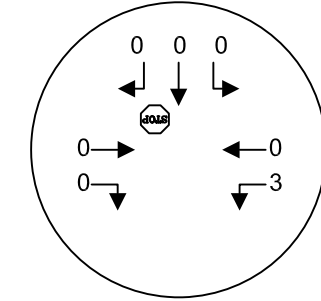

② RUSH RD & I-5 NB RAMPS

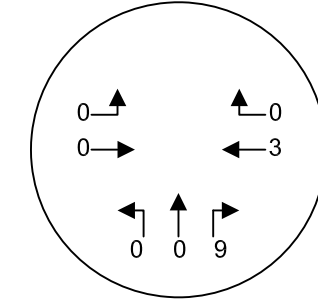

③ RUSH RD & KIRKLAND RD

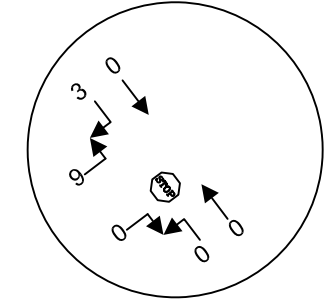

④ RUSH RD & BISHOP RD

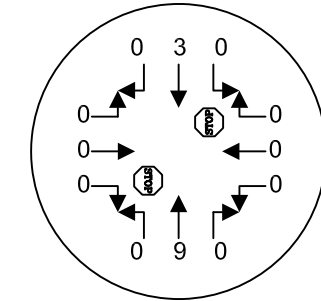

⑤ RUSH RD & MAURIN RD

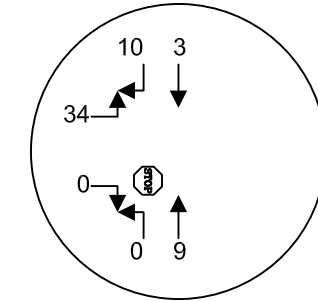

⑥ RUSH RD & JACKSON HWY

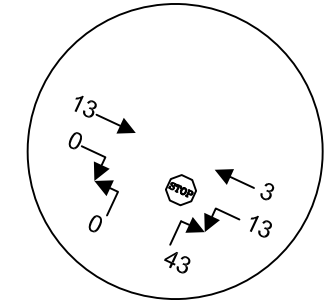

⑦ LABREE RD & I-5 NB RAMPS

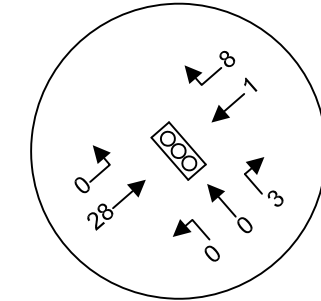

⑧ BISHOP RD & I-5 SB RAMPS

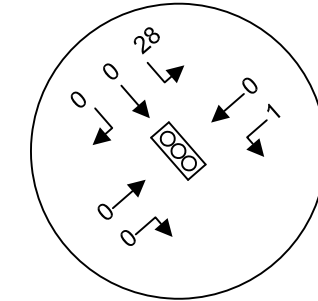

Ⓐ CONS. ACCESS & JACKSON HWY

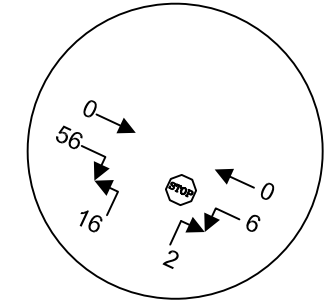

NEW AM PEAK HOUR TRIPS
 INBOUND: 62 VPH
 OUTBOUND: 18 VPH

JACKSON HIGHWAY WAREHOUSE
TRAFFIC IMPACT ANALYSIS

ITE TRIP GENERATION SHEETS

LUC 154 – HIGH-CUBE TRANSLOAD &
SHORT TERM STORAGE WAREHOUSE

APPENDIX

High-Cube Transload and Short-Term Storage Warehouse (154)

Vehicle Trip Ends vs: 1000 Sq. Ft. GFA
 On a: Weekday

Setting/Location: General Urban/Suburban
 Number of Studies: 91
 Avg. 1000 Sq. Ft. GFA: 798
 Directional Distribution: 50% entering, 50% exiting

Vehicle Trip Generation per 1000 Sq. Ft. GFA

Average Rate	Range of Rates	Standard Deviation
1.40	0.20 - 4.32	0.86

Data Plot and Equation

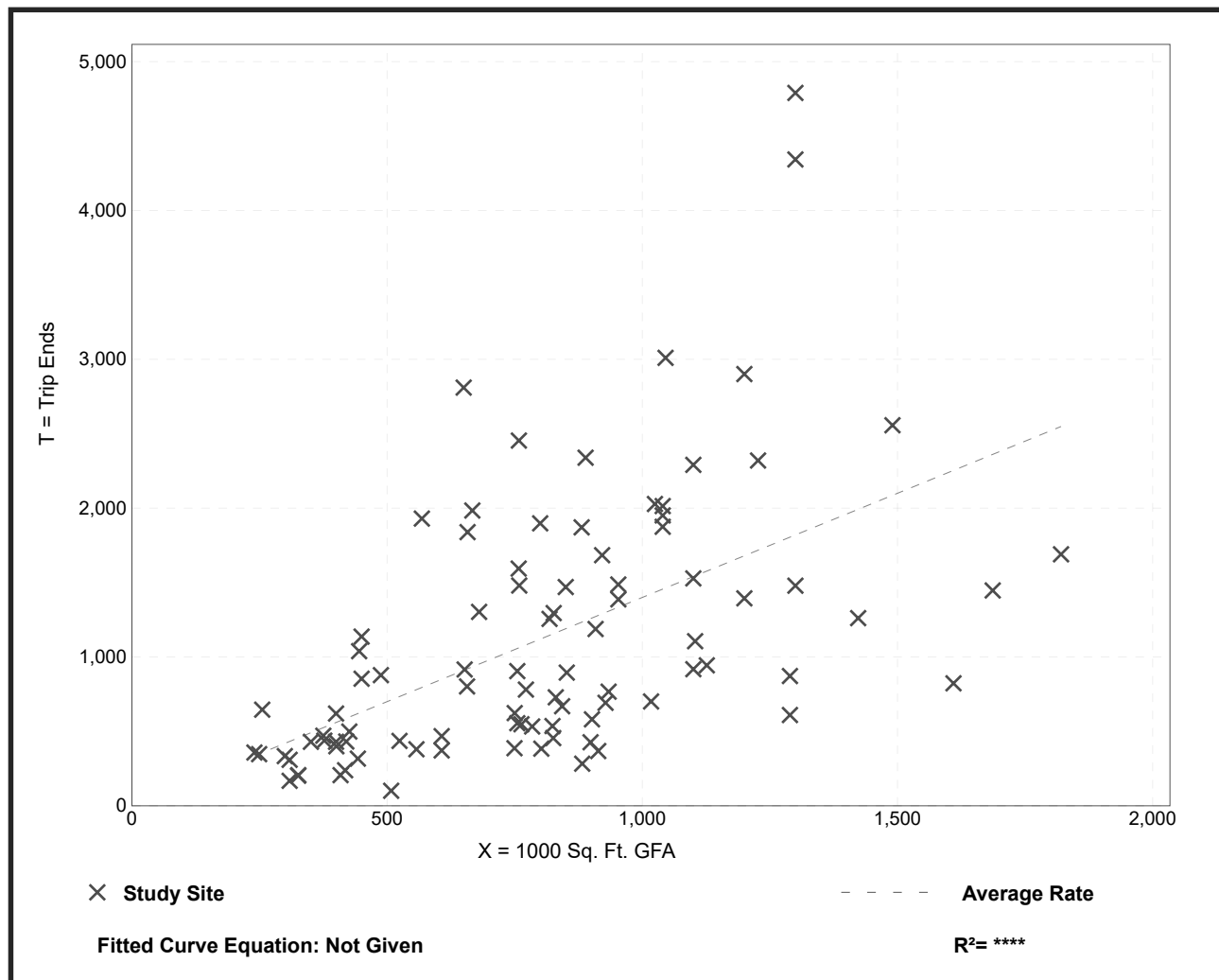

Trip Generation Manual, 10th Edition • Institute of Transportation Engineers

High-Cube Transload and Short-Term Storage Warehouse (154)

Vehicle Trip Ends vs: 1000 Sq. Ft. GFA
 On a: Weekday,
 Peak Hour of Adjacent Street Traffic,
 One Hour Between 7 and 9 a.m.
 Setting/Location: General Urban/Suburban
 Number of Studies: 102
 Avg. 1000 Sq. Ft. GFA: 846
 Directional Distribution: 77% entering, 23% exiting

Vehicle Trip Generation per 1000 Sq. Ft. GFA

Average Rate	Range of Rates	Standard Deviation
0.08	0.01 - 0.31	0.05

Data Plot and Equation

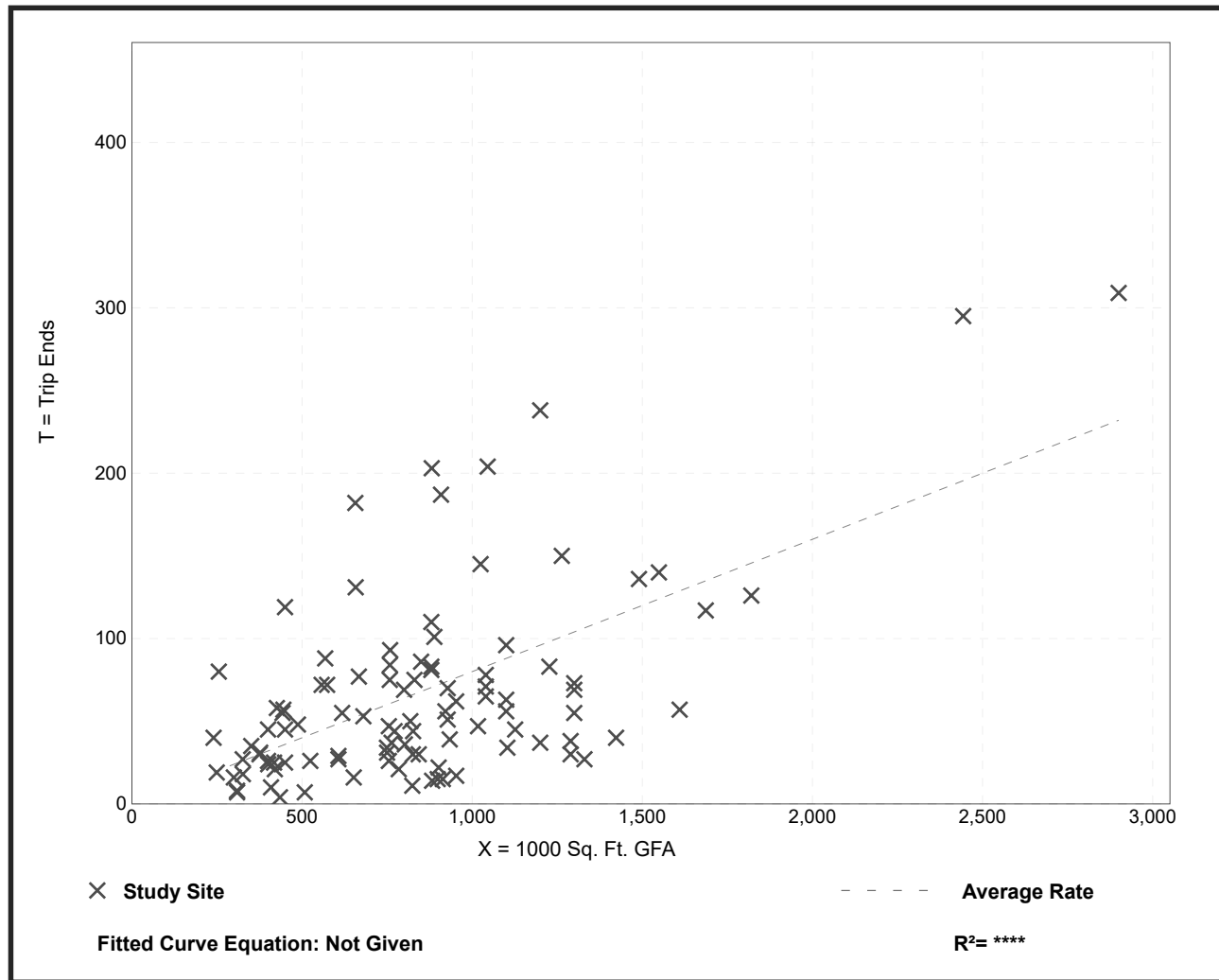

Trip Generation Manual, 10th Edition • Institute of Transportation Engineers

High-Cube Transload and Short-Term Storage Warehouse (154)

Vehicle Trip Ends vs: 1000 Sq. Ft. GFA
On a: Weekday,
Peak Hour of Adjacent Street Traffic,
One Hour Between 4 and 6 p.m.
Setting/Location: General Urban/Suburban
 Number of Studies: 103
 Avg. 1000 Sq. Ft. GFA: 840
 Directional Distribution: 28% entering, 72% exiting

Vehicle Trip Generation per 1000 Sq. Ft. GFA

Average Rate	Range of Rates	Standard Deviation
0.10	0.00 - 0.25	0.06

Data Plot and Equation

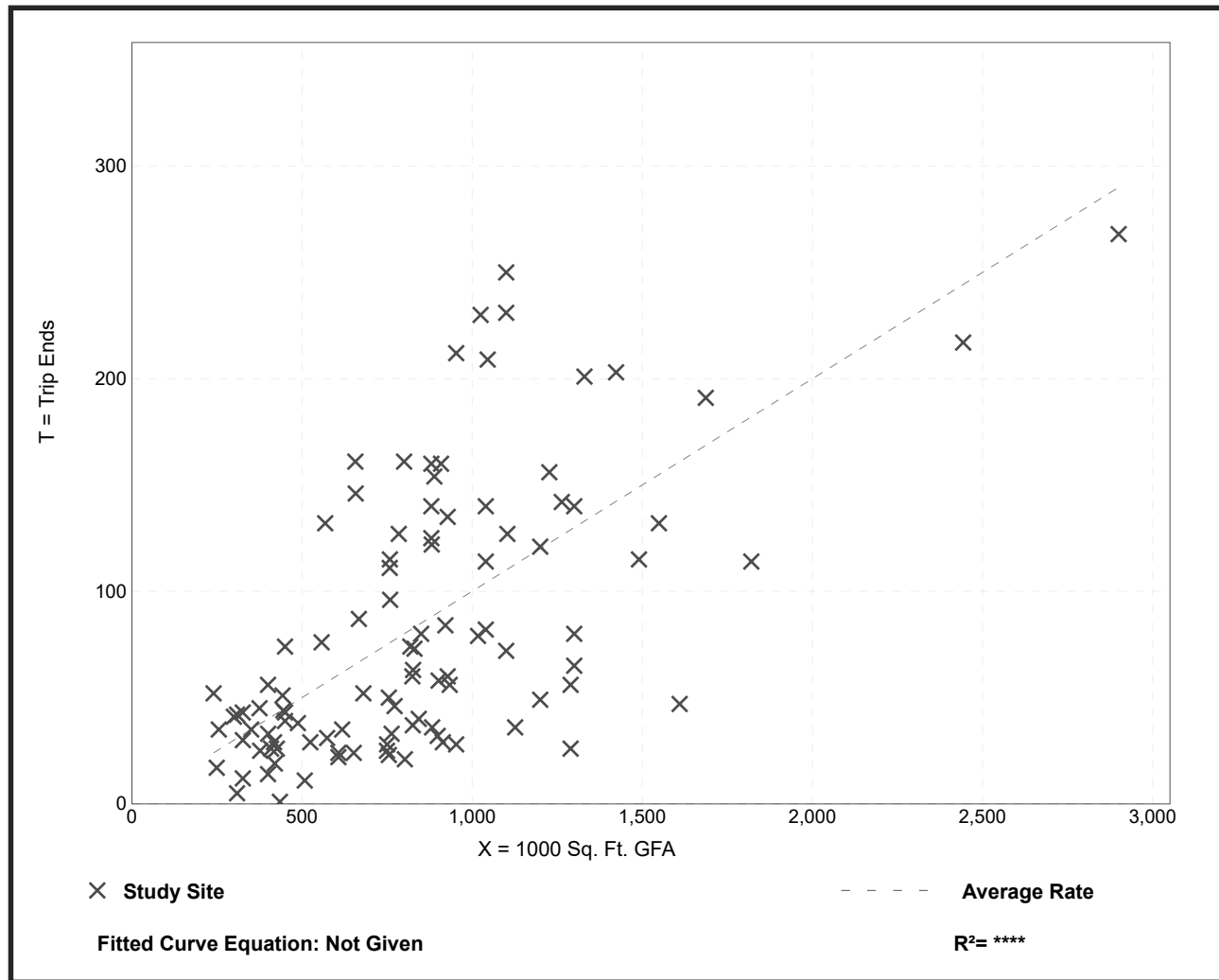

Trip Generation Manual, 10th Edition • Institute of Transportation Engineers

JACKSON HIGHWAY WAREHOUSE
TRAFFIC IMPACT ANALYSIS

LEVEL OF SERVICE

APPENDIX

Lanes, Volumes, Timings
7: I-5 NB Off-Ramp/I-5 NB On-Ramp & Labree Rd

Baseline 2020 PM Peak Hour
12/04/2020

Lane Group	EBL	EBT	EBR	WBL	WBT	WBR	NBL	NBT	NBR	SBL	SBT	SBR
Lane Configurations												
Traffic Volume (vph)	109	274	0	0	273	164	14	0	57	0	0	0
Future Volume (vph)	109	274	0	0	273	164	14	0	57	0	0	0
Satd. Flow (prot)	3400	3374	0	0	6052	1524	1491	1491	1302	0	0	0
Flt Permitted	0.950						0.950	0.950				
Satd. Flow (perm)	3400	3374	0	0	6052	1524	1491	1491	1302	0	0	0
Satd. Flow (RTOR)						186			65			
Lane Group Flow (vph)	124	311	0	0	310	186	8	8	65	0	0	0
Turn Type	Prot	NA			NA	Perm	Prot	NA	Prot			
Protected Phases	5	2			6		3	8	8			
Permitted Phases						6						
Total Split (s)	27.0	83.0			56.0	56.0	37.0	37.0	37.0			
Total Lost Time (s)	4.5	4.5			4.5	4.5	4.5	4.5	4.5			
Act Effct Green (s)	22.5	78.5			51.5	51.5	11.3	6.5	32.5			
Actuated g/C Ratio	0.19	0.65			0.43	0.43	0.09	0.05	0.27			
v/c Ratio	0.19	0.14			0.12	0.24	0.06	0.10	0.16			
Control Delay	33.6	6.9			20.8	3.8	43.3	35.0	9.0			
Queue Delay	0.0	0.0			0.0	0.0	0.0	0.0	0.0			
Total Delay	33.6	6.9			20.8	3.8	43.3	35.0	9.0			
LOS	C	A			C	A	D	C	A			
Approach Delay		14.6			14.4			15.0				
Approach LOS		B			B			B				
Queue Length 50th (ft)	27	32			41	0	6	~13	0			
Queue Length 95th (ft)	43	42			56	40	17	17	33			
Internal Link Dist (ft)		228			1025			631			380	
Turn Bay Length (ft)						325	325		250			
Base Capacity (vph)	637	2207			2597	760	403	81	400			
Starvation Cap Reductn	0	0			0	0	0	0	0			
Spillback Cap Reductn	0	0			0	0	0	0	0			
Storage Cap Reductn	0	0			0	0	0	0	0			
Reduced v/c Ratio	0.19	0.14			0.12	0.24	0.02	0.10	0.16			

Intersection Summary

Cycle Length: 120
 Actuated Cycle Length: 120
 Offset: 103 (86%), Referenced to phase 2:EBT and 6:WBT, Start of Green
 Control Type: Actuated-Coordinated
 Maximum v/c Ratio: 0.24
 Intersection Signal Delay: 14.5 Intersection LOS: B
 Intersection Capacity Utilization 29.7% ICU Level of Service A
 Analysis Period (min) 15
 ~ Volume exceeds capacity, queue is theoretically infinite.
 Queue shown is maximum after two cycles.

Splits and Phases: 7: I-5 NB Off-Ramp/I-5 NB On-Ramp & Labree Rd

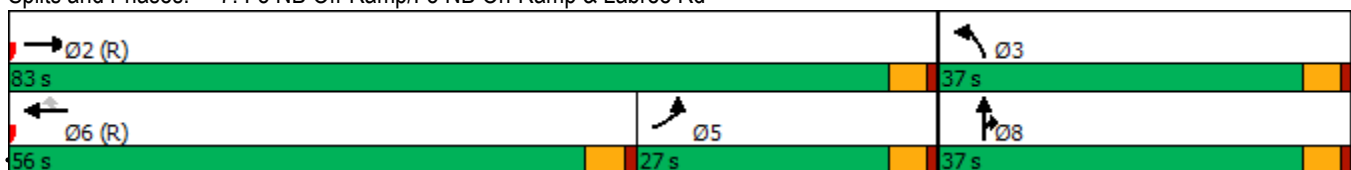

Lanes, Volumes, Timings

Synchro 10 Light Report
Page 1

Lanes, Volumes, Timings
 8: I-5 SB On-Ramp/I-5 SB Off-Ramp & Labree Rd

Baseline 2020 PM Peak Hour
 12/04/2020



Lane Group	EBL	EBT	EBR	WBL	WBT	WBR	NBL	NBT	NBR	SBL	SBT	SBR
Lane Configurations		↑↑↑↑		↔↔	↑↑					↔	↔	↔
Traffic Volume (vph)	0	98	11	203	84	0	0	0	0	276	2	40
Future Volume (vph)	0	98	11	203	84	0	0	0	0	276	2	40
Satd. Flow (prot)	0	6262	0	3183	3505	0	0	0	0	1603	1609	1455
Flt Permitted				0.950						0.950	0.953	
Satd. Flow (perm)	0	6262	0	3183	3505	0	0	0	0	1603	1609	1455
Satd. Flow (RTOR)		11										55
Lane Group Flow (vph)	0	112	0	209	87	0	0	0	0	142	145	41
Turn Type		NA		Prot	NA					Prot	NA	Prot
Protected Phases		2		1	6					7	4	4
Permitted Phases												
Total Split (s)		29.0		39.0	68.0					52.0	52.0	52.0
Total Lost Time (s)		4.5		4.5	4.5					4.5	4.5	4.5
Act Effct Green (s)		24.5		34.5	63.5					47.5	47.5	47.5
Actuated g/C Ratio		0.20		0.29	0.53					0.40	0.40	0.40
v/c Ratio		0.09		0.23	0.05					0.22	0.23	0.07
Control Delay		35.1		14.3	2.6					25.2	25.3	4.0
Queue Delay		0.0		0.0	0.0					0.0	0.0	0.0
Total Delay		35.1		14.3	2.6					25.2	25.3	4.0
LOS		D		B	A					C	C	A
Approach Delay		35.1			10.8						22.6	
Approach LOS		D			B						C	
Queue Length 50th (ft)		18		64	2					75	77	0
Queue Length 95th (ft)		32		97	5					126	129	16
Internal Link Dist (ft)		635			228			826			449	
Turn Bay Length (ft)												
Base Capacity (vph)		1287		915	1854					634	636	609
Starvation Cap Reductn		0		0	0					0	0	0
Spillback Cap Reductn		0		0	0					0	0	0
Storage Cap Reductn		0		0	0					0	0	0
Reduced v/c Ratio		0.09		0.23	0.05					0.22	0.23	0.07

Intersection Summary

Cycle Length: 120
 Actuated Cycle Length: 120
 Offset: 94 (78%), Referenced to phase 2:EBT and 6:WBT, Start of Green
 Control Type: Actuated-Coordinated
 Maximum v/c Ratio: 0.23
 Intersection Signal Delay: 19.8
 Intersection LOS: B
 Intersection Capacity Utilization 29.7%
 ICU Level of Service A
 Analysis Period (min) 15

Splits and Phases: 8: I-5 SB On-Ramp/I-5 SB Off-Ramp & Labree Rd

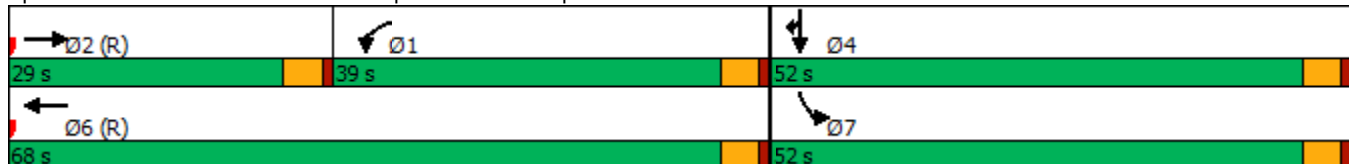

Intersection												
Int Delay, s/veh	6.8											
Movement	EBL	EBT	EBR	WBL	WBT	WBR	NBL	NBT	NBR	SBL	SBT	SBR
Lane Configurations		↻			↻					↻	↻	
Traffic Vol, veh/h	0	287	139	92	274	0	0	0	0	100	1	318
Future Vol, veh/h	0	287	139	92	274	0	0	0	0	100	1	318
Conflicting Peds, #/hr	0	0	0	0	0	0	0	0	0	0	0	0
Sign Control	Free	Free	Free	Free	Free	Free	Stop	Stop	Stop	Stop	Stop	Stop
RT Channelized	-	-	None	-	-	None	-	-	None	-	-	None
Storage Length	-	-	-	-	-	-	-	-	-	50	-	-
Veh in Median Storage, #	-	0	-	-	0	-	-	16974	-	-	0	-
Grade, %	-	0	-	-	0	-	-	0	-	-	0	-
Peak Hour Factor	92	92	92	92	92	92	92	92	92	92	92	92
Heavy Vehicles, %	1	11	22	16	13	1	2	2	2	13	1	11
Mvmt Flow	0	312	151	100	298	0	0	0	0	109	1	346

Major/Minor	Major1			Major2			Minor2			
Conflicting Flow All	-	0	0	463	0	0		886	961	298
Stage 1	-	-	-	-	-	-		498	498	-
Stage 2	-	-	-	-	-	-		388	463	-
Critical Hdwy	-	-	-	4.26	-	-		6.53	6.51	6.31
Critical Hdwy Stg 1	-	-	-	-	-	-		5.53	5.51	-
Critical Hdwy Stg 2	-	-	-	-	-	-		5.53	5.51	-
Follow-up Hdwy	-	-	-	2.344	-	-		3.617	4.009	3.399
Pot Cap-1 Maneuver	0	-	-	1029	-	0		301	257	721
Stage 1	0	-	-	-	-	0		589	546	-
Stage 2	0	-	-	-	-	0		662	566	-
Platoon blocked, %		-	-	-						
Mov Cap-1 Maneuver	-	-	-	1029	-	-		266	0	721
Mov Cap-2 Maneuver	-	-	-	-	-	-		266	0	-
Stage 1	-	-	-	-	-	-		589	0	-
Stage 2	-	-	-	-	-	-		585	0	-

Approach	EB	WB	SB
HCM Control Delay, s	0	2.2	17.6
HCM LOS			C

Minor Lane/Major Mvmt	EBT	EBR	WBL	WBT	SBLn1	SBLn2
Capacity (veh/h)	-	-	1029	-	266	721
HCM Lane V/C Ratio	-	-	0.097	-	0.409	0.481
HCM Control Delay (s)	-	-	8.9	0	27.6	14.5
HCM Lane LOS	-	-	A	A	D	B
HCM 95th %tile Q(veh)	-	-	0.3	-	1.9	2.6

Intersection												
Int Delay, s/veh	6.6											
Movement	EBL	EBT	EBR	WBL	WBT	WBR	NBL	NBT	NBR	SBL	SBT	SBR
Lane Configurations		↔			↔		↔	↔				
Traffic Vol, veh/h	180	212	0	0	259	122	106	0	114	0	0	0
Future Vol, veh/h	180	212	0	0	259	122	106	0	114	0	0	0
Conflicting Peds, #/hr	0	0	0	0	0	0	0	0	0	0	0	0
Sign Control	Free	Free	Free	Free	Free	Free	Stop	Stop	Stop	Stop	Stop	Stop
RT Channelized	-	-	None	-	-	None	-	-	None	-	-	None
Storage Length	-	-	-	-	-	-	50	-	-	-	-	-
Veh in Median Storage, #	-	0	-	-	0	-	-	0	-	-	16965	-
Grade, %	-	0	-	-	0	-	-	0	-	-	0	-
Peak Hour Factor	98	98	98	98	98	98	98	98	98	98	98	98
Heavy Vehicles, %	16	7	1	1	7	9	28	1	10	2	2	2
Mvmt Flow	184	216	0	0	264	124	108	0	116	0	0	0

Major/Minor	Major1	Major2	Minor1
Conflicting Flow All	388	0	-
Stage 1	-	-	-
Stage 2	-	-	-
Critical Hdwy	4.26	-	-
Critical Hdwy Stg 1	-	-	-
Critical Hdwy Stg 2	-	-	-
Follow-up Hdwy	2.344	-	-
Pot Cap-1 Maneuver	1098	-	0
Stage 1	-	-	0
Stage 2	-	-	0
Platoon blocked, %	-	-	-
Mov Cap-1 Maneuver	1098	-	-
Mov Cap-2 Maneuver	-	-	-
Stage 1	-	-	-
Stage 2	-	-	-

Approach	EB	WB	NB
HCM Control Delay, s	4.1	0	22.5
HCM LOS			C

Minor Lane/Major Mvmt	NBLn1	NBLn2	EBL	EBT	WBT	WBR
Capacity (veh/h)	222	804	1098	-	-	-
HCM Lane V/C Ratio	0.487	0.145	0.167	-	-	-
HCM Control Delay (s)	35.7	10.2	8.9	0	-	-
HCM Lane LOS	E	B	A	A	-	-
HCM 95th %tile Q(veh)	2.4	0.5	0.6	-	-	-

Intersection						
Int Delay, s/veh	7.1					
Movement	EBL	EBR	NBL	NBT	SBT	SBR
Lane Configurations						
Traffic Vol, veh/h	189	134	116	35	50	259
Future Vol, veh/h	189	134	116	35	50	259
Conflicting Peds, #/hr	0	0	0	0	0	0
Sign Control	Stop	Stop	Free	Free	Free	Free
RT Channelized	-	None	-	None	-	None
Storage Length	0	50	-	-	-	-
Veh in Median Storage, #	0	-	-	0	0	-
Grade, %	0	-	-	0	0	-
Peak Hour Factor	97	97	97	97	97	97
Heavy Vehicles, %	12	3	2	1	4	10
Mvmt Flow	195	138	120	36	52	267

Major/Minor	Minor2	Major1	Major2			
Conflicting Flow All	462	186	319	0	-	0
Stage 1	186	-	-	-	-	-
Stage 2	276	-	-	-	-	-
Critical Hdwy	6.52	6.23	4.12	-	-	-
Critical Hdwy Stg 1	5.52	-	-	-	-	-
Critical Hdwy Stg 2	5.52	-	-	-	-	-
Follow-up Hdwy	3.608	3.327	2.218	-	-	-
Pot Cap-1 Maneuver	540	854	1241	-	-	-
Stage 1	822	-	-	-	-	-
Stage 2	748	-	-	-	-	-
Platoon blocked, %				-	-	-
Mov Cap-1 Maneuver	487	854	1241	-	-	-
Mov Cap-2 Maneuver	487	-	-	-	-	-
Stage 1	741	-	-	-	-	-
Stage 2	748	-	-	-	-	-

Approach	EB	NB	SB
HCM Control Delay, s	14.2	6.3	0
HCM LOS	B		

Minor Lane/Major Mvmt	NBL	NBT	EBLn1	EBLn2	SBT	SBR
Capacity (veh/h)	1241	-	487	854	-	-
HCM Lane V/C Ratio	0.096	-	0.4	0.162	-	-
HCM Control Delay (s)	8.2	0	17.2	10	-	-
HCM Lane LOS	A	A	C	B	-	-
HCM 95th %tile Q(veh)	0.3	-	1.9	0.6	-	-

Intersection												
Int Delay, s/veh	5.7											
Movement	EBL	EBT	EBR	WBL	WBT	WBR	NBL	NBT	NBR	SBL	SBT	SBR
Lane Configurations		↕			↕			↕			↕	
Traffic Vol, veh/h	2	60	78	39	38	2	21	83	33	2	105	4
Future Vol, veh/h	2	60	78	39	38	2	21	83	33	2	105	4
Conflicting Peds, #/hr	0	0	0	0	0	0	0	0	0	0	0	0
Sign Control	Stop	Stop	Stop	Stop	Stop	Stop	Free	Free	Free	Free	Free	Free
RT Channelized	-	-	None	-	-	None	-	-	None	-	-	None
Storage Length	-	-	-	-	-	-	-	-	-	-	-	-
Veh in Median Storage, #	-	0	-	-	0	-	-	0	-	-	0	-
Grade, %	-	0	-	-	0	-	-	0	-	-	0	-
Peak Hour Factor	95	95	95	95	95	95	95	95	95	95	95	95
Heavy Vehicles, %	1	4	7	3	1	1	5	5	3	1	1	1
Mvmt Flow	2	63	82	41	40	2	22	87	35	2	111	4

Major/Minor	Minor2		Minor1		Major1		Major2					
Conflicting Flow All	287	283	113	339	268	105	115	0	0	122	0	0
Stage 1	117	117	-	149	149	-	-	-	-	-	-	-
Stage 2	170	166	-	190	119	-	-	-	-	-	-	-
Critical Hdwy	7.11	6.54	6.27	7.13	6.51	6.21	4.15	-	-	4.11	-	-
Critical Hdwy Stg 1	6.11	5.54	-	6.13	5.51	-	-	-	-	-	-	-
Critical Hdwy Stg 2	6.11	5.54	-	6.13	5.51	-	-	-	-	-	-	-
Follow-up Hdwy	3.509	4.036	3.363	3.527	4.009	3.309	2.245	-	-	2.209	-	-
Pot Cap-1 Maneuver	667	623	926	613	640	952	1455	-	-	1472	-	-
Stage 1	890	795	-	851	776	-	-	-	-	-	-	-
Stage 2	834	757	-	809	799	-	-	-	-	-	-	-
Platoon blocked, %								-	-	-	-	-
Mov Cap-1 Maneuver	625	612	926	508	629	952	1455	-	-	1472	-	-
Mov Cap-2 Maneuver	625	612	-	508	629	-	-	-	-	-	-	-
Stage 1	876	794	-	837	764	-	-	-	-	-	-	-
Stage 2	776	745	-	678	798	-	-	-	-	-	-	-

Approach	EB		WB		NB		SB	
HCM Control Delay, s	10.9		12.4		1.2		0.1	
HCM LOS	B		B					

Minor Lane/Major Mvmt	NBL	NBT	NBR	EBLn1	WBLn1	SBL	SBT	SBR
Capacity (veh/h)	1455	-	-	755	567	1472	-	-
HCM Lane V/C Ratio	0.015	-	-	0.195	0.147	0.001	-	-
HCM Control Delay (s)	7.5	0	-	10.9	12.4	7.4	0	-
HCM Lane LOS	A	A	-	B	B	A	A	-
HCM 95th %tile Q(veh)	0	-	-	0.7	0.5	0	-	-

Intersection						
Int Delay, s/veh	4.9					
Movement	EBL	EBR	NBL	NBT	SBT	SBR
Lane Configurations	T			T		
Traffic Vol, veh/h	121	28	33	58	81	69
Future Vol, veh/h	121	28	33	58	81	69
Conflicting Peds, #/hr	0	0	0	0	0	0
Sign Control	Stop	Stop	Free	Free	Free	Free
RT Channelized	-	None	-	None	-	None
Storage Length	0	-	-	-	-	-
Veh in Median Storage, #	0	-	-	0	0	-
Grade, %	0	-	-	0	0	-
Peak Hour Factor	92	92	92	92	92	92
Heavy Vehicles, %	3	1	10	2	1	6
Mvmt Flow	132	30	36	63	88	75

Major/Minor	Minor2	Major1	Major2			
Conflicting Flow All	261	126	163	0	-	0
Stage 1	126	-	-	-	-	-
Stage 2	135	-	-	-	-	-
Critical Hdwy	6.43	6.21	4.2	-	-	-
Critical Hdwy Stg 1	5.43	-	-	-	-	-
Critical Hdwy Stg 2	5.43	-	-	-	-	-
Follow-up Hdwy	3.527	3.309	2.29	-	-	-
Pot Cap-1 Maneuver	726	927	1368	-	-	-
Stage 1	897	-	-	-	-	-
Stage 2	889	-	-	-	-	-
Platoon blocked, %				-	-	-
Mov Cap-1 Maneuver	706	927	1368	-	-	-
Mov Cap-2 Maneuver	706	-	-	-	-	-
Stage 1	873	-	-	-	-	-
Stage 2	889	-	-	-	-	-

Approach	EB	NB	SB
HCM Control Delay, s	11.2	2.8	0
HCM LOS	B		

Minor Lane/Major Mvmt	NBL	NBT	EBLn1	SBT	SBR
Capacity (veh/h)	1368	-	739	-	-
HCM Lane V/C Ratio	0.026	-	0.219	-	-
HCM Control Delay (s)	7.7	0	11.2	-	-
HCM Lane LOS	A	A	B	-	-
HCM 95th %tile Q(veh)	0.1	-	0.8	-	-

Intersection						
Int Delay, s/veh	3.3					
Movement	EBT	EBR	WBL	WBT	NBL	NBR
Lane Configurations	↑	↗		↖	↖	↗
Traffic Vol, veh/h	293	104	50	140	80	93
Future Vol, veh/h	293	104	50	140	80	93
Conflicting Peds, #/hr	0	0	0	0	0	0
Sign Control	Free	Free	Free	Free	Stop	Stop
RT Channelized	-	None	-	None	-	None
Storage Length	-	200	-	-	0	125
Veh in Median Storage, #	0	-	-	0	0	-
Grade, %	0	-	-	0	0	-
Peak Hour Factor	97	97	97	97	97	97
Heavy Vehicles, %	1	1	6	2	4	3
Mvmt Flow	302	107	52	144	82	96

Major/Minor	Major1	Major2	Minor1		
Conflicting Flow All	0	0	409	0	550 302
Stage 1	-	-	-	-	302 -
Stage 2	-	-	-	-	248 -
Critical Hdwy	-	-	4.16	-	6.44 6.23
Critical Hdwy Stg 1	-	-	-	-	5.44 -
Critical Hdwy Stg 2	-	-	-	-	5.44 -
Follow-up Hdwy	-	-	2.254	-	3.536 3.327
Pot Cap-1 Maneuver	-	-	1129	-	493 735
Stage 1	-	-	-	-	745 -
Stage 2	-	-	-	-	789 -
Platoon blocked, %	-	-	-	-	-
Mov Cap-1 Maneuver	-	-	1129	-	468 735
Mov Cap-2 Maneuver	-	-	-	-	468 -
Stage 1	-	-	-	-	745 -
Stage 2	-	-	-	-	750 -

Approach	EB	WB	NB
HCM Control Delay, s	0	2.2	12.3
HCM LOS			B

Minor Lane/Major Mvmt	NBLn1	NBLn2	EBT	EBR	WBL	WBT
Capacity (veh/h)	468	735	-	-	1129	-
HCM Lane V/C Ratio	0.176	0.13	-	-	0.046	-
HCM Control Delay (s)	14.3	10.6	-	-	8.3	0
HCM Lane LOS	B	B	-	-	A	A
HCM 95th %tile Q(veh)	0.6	0.4	-	-	0.1	-

Lanes, Volumes, Timings

Forecast 2025 PM Peak Hour Without Project

7: I-5 NB Off-Ramp/I-5 NB On-Ramp & Labree Rd

12/04/2020

Lane Group	EBL	EBT	EBR	WBL	WBT	WBR	NBL	NBT	NBR	SBL	SBT	SBR
Lane Configurations												
Traffic Volume (vph)	117	295	0	0	294	177	15	0	61	0	0	0
Future Volume (vph)	117	295	0	0	294	177	15	0	61	0	0	0
Satd. Flow (prot)	3400	3374	0	0	6052	1524	1491	1491	1302	0	0	0
Flt Permitted	0.950						0.950	0.950				
Satd. Flow (perm)	3400	3374	0	0	6052	1524	1491	1491	1302	0	0	0
Satd. Flow (RTOR)						201			69			
Lane Group Flow (vph)	133	335	0	0	334	201	8	9	69	0	0	0
Turn Type	Prot	NA			NA	Perm	Prot	NA	Prot			
Protected Phases	5	2			6		3	8	8			
Permitted Phases						6						
Total Split (s)	27.0	83.0			56.0	56.0	37.0	37.0	37.0			
Total Lost Time (s)	4.5	4.5			4.5	4.5	4.5	4.5	4.5			
Act Effct Green (s)	22.5	78.5			51.5	51.5	11.3	6.5	32.5			
Actuated g/C Ratio	0.19	0.65			0.43	0.43	0.09	0.05	0.27			
v/c Ratio	0.21	0.15			0.13	0.26	0.06	0.11	0.17			
Control Delay	34.0	7.1			20.9	3.8	43.3	35.4	8.8			
Queue Delay	0.0	0.0			0.0	0.0	0.0	0.0	0.0			
Total Delay	34.0	7.1			20.9	3.8	43.3	35.4	8.8			
LOS	C	A			C	A	D	D	A			
Approach Delay		14.8			14.4			14.8				
Approach LOS		B			B			B				
Queue Length 50th (ft)	28	34			44	0	6	~15	0			
Queue Length 95th (ft)	46	46			59	41	17	20	34			
Internal Link Dist (ft)		228			1025			631			380	
Turn Bay Length (ft)						325	325		250			
Base Capacity (vph)	637	2207			2597	768	403	81	402			
Starvation Cap Reductn	0	0			0	0	0	0	0			
Spillback Cap Reductn	0	0			0	0	0	0	0			
Storage Cap Reductn	0	0			0	0	0	0	0			
Reduced v/c Ratio	0.21	0.15			0.13	0.26	0.02	0.11	0.17			

Intersection Summary

Cycle Length: 120

Actuated Cycle Length: 120

Offset: 103 (86%), Referenced to phase 2:EBT and 6:WBT, Start of Green

Control Type: Actuated-Coordinated

Maximum v/c Ratio: 0.26

Intersection Signal Delay: 14.6

Intersection LOS: B

Intersection Capacity Utilization 30.5%

ICU Level of Service A

Analysis Period (min) 15

~ Volume exceeds capacity, queue is theoretically infinite.

Queue shown is maximum after two cycles.

Splits and Phases: 7: I-5 NB Off-Ramp/I-5 NB On-Ramp & Labree Rd

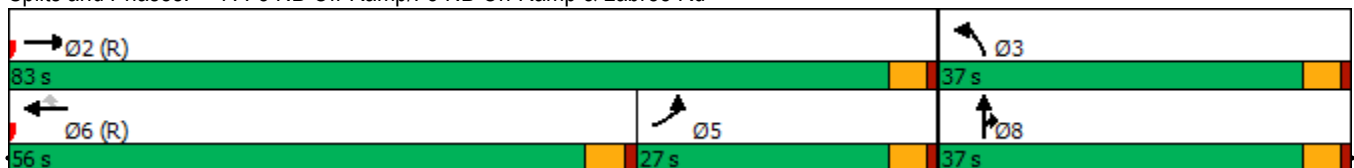

Lanes, Volumes, Timings

Synchro 10 Light Report

Page 1

Lanes, Volumes, Timings
8: I-5 SB On-Ramp/I-5 SB Off-Ramp & Labree Rd

Forecast 2025 PM Peak Hour Without Project
12/04/2020



Lane Group	EBL	EBT	EBR	WBL	WBT	WBR	NBL	NBT	NBR	SBL	SBT	SBR
Lane Configurations		↑↑↑↑		↔↔	↑↑					↔	↔	↔
Traffic Volume (vph)	0	106	12	219	90	0	0	0	0	297	2	43
Future Volume (vph)	0	106	12	219	90	0	0	0	0	297	2	43
Satd. Flow (prot)	0	6263	0	3183	3505	0	0	0	0	1603	1609	1455
Flt Permitted				0.950						0.950	0.953	
Satd. Flow (perm)	0	6263	0	3183	3505	0	0	0	0	1603	1609	1455
Satd. Flow (RTOR)		12										55
Lane Group Flow (vph)	0	121	0	226	93	0	0	0	0	153	155	44
Turn Type		NA		Prot	NA					Prot	NA	Prot
Protected Phases		2		1	6					7	4	4
Permitted Phases												
Total Split (s)		29.0		39.0	68.0					52.0	52.0	52.0
Total Lost Time (s)		4.5		4.5	4.5					4.5	4.5	4.5
Act Effct Green (s)		24.5		34.5	63.5					47.5	47.5	47.5
Actuated g/C Ratio		0.20		0.29	0.53					0.40	0.40	0.40
v/c Ratio		0.09		0.25	0.05					0.24	0.24	0.07
Control Delay		35.1		14.4	2.6					25.5	25.6	4.7
Queue Delay		0.0		0.0	0.0					0.0	0.0	0.0
Total Delay		35.1		14.4	2.6					25.5	25.6	4.7
LOS		D		B	A					C	C	A
Approach Delay		35.1			11.0						22.9	
Approach LOS		D			B						C	
Queue Length 50th (ft)		20		70	2					82	83	0
Queue Length 95th (ft)		34		104	5					135	136	19
Internal Link Dist (ft)		635			228			826			449	
Turn Bay Length (ft)												
Base Capacity (vph)		1288		915	1854					634	636	609
Starvation Cap Reductn		0		0	0					0	0	0
Spillback Cap Reductn		0		0	0					0	0	0
Storage Cap Reductn		0		0	0					0	0	0
Reduced v/c Ratio		0.09		0.25	0.05					0.24	0.24	0.07

Intersection Summary

Cycle Length: 120
 Actuated Cycle Length: 120
 Offset: 94 (78%), Referenced to phase 2:EBT and 6:WBT, Start of Green
 Control Type: Actuated-Coordinated
 Maximum v/c Ratio: 0.25
 Intersection Signal Delay: 20.0
 Intersection Capacity Utilization 30.5%
 Analysis Period (min) 15
 Intersection LOS: B
 ICU Level of Service A

Splits and Phases: 8: I-5 SB On-Ramp/I-5 SB Off-Ramp & Labree Rd

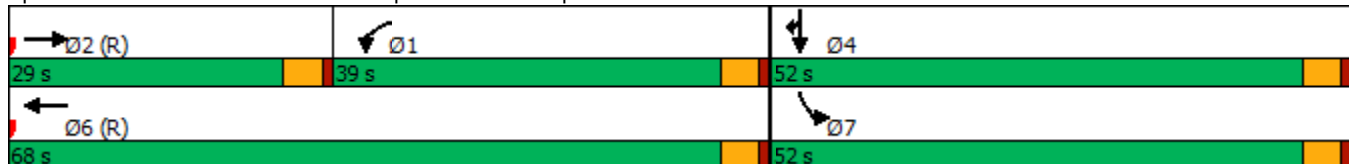

Intersection												
Int Delay, s/veh	7.7											
Movement	EBL	EBT	EBR	WBL	WBT	WBR	NBL	NBT	NBR	SBL	SBT	SBR
Lane Configurations		↻			↻					↻	↻	
Traffic Vol, veh/h	0	309	150	99	295	0	0	0	0	108	1	343
Future Vol, veh/h	0	309	150	99	295	0	0	0	0	108	1	343
Conflicting Peds, #/hr	0	0	0	0	0	0	0	0	0	0	0	0
Sign Control	Free	Free	Free	Free	Free	Free	Stop	Stop	Stop	Stop	Stop	Stop
RT Channelized	-	-	None	-	-	None	-	-	None	-	-	None
Storage Length	-	-	-	-	-	-	-	-	-	50	-	-
Veh in Median Storage, #	-	0	-	-	0	-	-	16974	-	-	0	-
Grade, %	-	0	-	-	0	-	-	0	-	-	0	-
Peak Hour Factor	92	92	92	92	92	92	92	92	92	92	92	92
Heavy Vehicles, %	1	11	22	16	13	1	2	2	2	13	1	11
Mvmt Flow	0	336	163	108	321	0	0	0	0	117	1	373

Major/Minor	Major1			Major2			Minor2			
Conflicting Flow All	-	0	0	499	0	0		955	1036	321
Stage 1	-	-	-	-	-	-		537	537	-
Stage 2	-	-	-	-	-	-		418	499	-
Critical Hdwy	-	-	-	4.26	-	-		6.53	6.51	6.31
Critical Hdwy Stg 1	-	-	-	-	-	-		5.53	5.51	-
Critical Hdwy Stg 2	-	-	-	-	-	-		5.53	5.51	-
Follow-up Hdwy	-	-	-	2.344	-	-		3.617	4.009	3.399
Pot Cap-1 Maneuver	0	-	-	997	-	0		274	232	699
Stage 1	0	-	-	-	-	0		564	524	-
Stage 2	0	-	-	-	-	0		641	545	-
Platoon blocked, %	-	-	-	-	-	-		-	-	-
Mov Cap-1 Maneuver	-	-	-	997	-	-		238	0	699
Mov Cap-2 Maneuver	-	-	-	-	-	-		238	0	-
Stage 1	-	-	-	-	-	-		564	0	-
Stage 2	-	-	-	-	-	-		556	0	-

Approach	EB	WB	SB
HCM Control Delay, s	0	2.3	20.2
HCM LOS			C

Minor Lane/Major Mvmt	EBT	EBR	WBL	WBT	SBLn1	SBLn2
Capacity (veh/h)	-	-	997	-	238	699
HCM Lane V/C Ratio	-	-	0.108	-	0.493	0.535
HCM Control Delay (s)	-	-	9	0	34	15.9
HCM Lane LOS	-	-	A	A	D	C
HCM 95th %tile Q(veh)	-	-	0.4	-	2.5	3.2

Intersection												
Int Delay, s/veh	7.9											
Movement	EBL	EBT	EBR	WBL	WBT	WBR	NBL	NBT	NBR	SBL	SBT	SBR
Lane Configurations		↔			↔		↔	↔				
Traffic Vol, veh/h	194	228	0	0	279	131	114	0	123	0	0	0
Future Vol, veh/h	194	228	0	0	279	131	114	0	123	0	0	0
Conflicting Peds, #/hr	0	0	0	0	0	0	0	0	0	0	0	0
Sign Control	Free	Free	Free	Free	Free	Free	Stop	Stop	Stop	Stop	Stop	Stop
RT Channelized	-	-	None	-	-	None	-	-	None	-	-	None
Storage Length	-	-	-	-	-	-	50	-	-	-	-	-
Veh in Median Storage, #	-	0	-	-	0	-	-	0	-	-	16965	-
Grade, %	-	0	-	-	0	-	-	0	-	-	0	-
Peak Hour Factor	98	98	98	98	98	98	98	98	98	98	98	98
Heavy Vehicles, %	16	7	1	1	7	9	28	1	10	2	2	2
Mvmt Flow	198	233	0	0	285	134	116	0	126	0	0	0

Major/Minor	Major1	Major2	Minor1
Conflicting Flow All	419	0	-
Stage 1	-	-	-
Stage 2	-	-	-
Critical Hdwy	4.26	-	-
Critical Hdwy Stg 1	-	-	-
Critical Hdwy Stg 2	-	-	-
Follow-up Hdwy	2.344	-	-
Pot Cap-1 Maneuver	1069	0	0
Stage 1	-	0	0
Stage 2	-	0	0
Platoon blocked, %	-	-	-
Mov Cap-1 Maneuver	1069	-	-
Mov Cap-2 Maneuver	-	-	-
Stage 1	-	-	-
Stage 2	-	-	-

Approach	EB	WB	NB
HCM Control Delay, s	4.2	0	28.3
HCM LOS			D

Minor Lane/Major Mvmt	NBLn1	NBLn2	EBL	EBT	WBT	WBR
Capacity (veh/h)	195	787	1069	-	-	-
HCM Lane V/C Ratio	0.597	0.159	0.185	-	-	-
HCM Control Delay (s)	47.6	10.4	9.1	0	-	-
HCM Lane LOS	E	B	A	A	-	-
HCM 95th %tile Q(veh)	3.3	0.6	0.7	-	-	-

Intersection						
Int Delay, s/veh	7.6					
Movement	EBL	EBR	NBL	NBT	SBT	SBR
Lane Configurations						
Traffic Vol, veh/h	204	144	125	38	54	279
Future Vol, veh/h	204	144	125	38	54	279
Conflicting Peds, #/hr	0	0	0	0	0	0
Sign Control	Stop	Stop	Free	Free	Free	Free
RT Channelized	-	None	-	None	-	None
Storage Length	0	50	-	-	-	-
Veh in Median Storage, #	0	-	-	0	0	-
Grade, %	0	-	-	0	0	-
Peak Hour Factor	97	97	97	97	97	97
Heavy Vehicles, %	12	3	2	1	4	10
Mvmt Flow	210	148	129	39	56	288

Major/Minor	Minor2	Major1	Major2			
Conflicting Flow All	497	200	344	0	-	0
Stage 1	200	-	-	-	-	-
Stage 2	297	-	-	-	-	-
Critical Hdwy	6.52	6.23	4.12	-	-	-
Critical Hdwy Stg 1	5.52	-	-	-	-	-
Critical Hdwy Stg 2	5.52	-	-	-	-	-
Follow-up Hdwy	3.608	3.327	2.218	-	-	-
Pot Cap-1 Maneuver	515	838	1215	-	-	-
Stage 1	810	-	-	-	-	-
Stage 2	732	-	-	-	-	-
Platoon blocked, %				-	-	-
Mov Cap-1 Maneuver	459	838	1215	-	-	-
Mov Cap-2 Maneuver	459	-	-	-	-	-
Stage 1	722	-	-	-	-	-
Stage 2	732	-	-	-	-	-

Approach	EB	NB	SB
HCM Control Delay, s	15.5	6.4	0
HCM LOS	C		

Minor Lane/Major Mvmt	NBL	NBT	EBLn1	EBLn2	SBT	SBR
Capacity (veh/h)	1215	-	459	838	-	-
HCM Lane V/C Ratio	0.106	-	0.458	0.177	-	-
HCM Control Delay (s)	8.3	0	19.3	10.2	-	-
HCM Lane LOS	A	A	C	B	-	-
HCM 95th %tile Q(veh)	0.4	-	2.4	0.6	-	-

Intersection												
Int Delay, s/veh	5.9											
Movement	EBL	EBT	EBR	WBL	WBT	WBR	NBL	NBT	NBR	SBL	SBT	SBR
Lane Configurations		↕			↕			↕			↕	
Traffic Vol, veh/h	2	65	84	42	41	2	23	89	36	2	113	5
Future Vol, veh/h	2	65	84	42	41	2	23	89	36	2	113	5
Conflicting Peds, #/hr	0	0	0	0	0	0	0	0	0	0	0	0
Sign Control	Stop	Stop	Stop	Stop	Stop	Stop	Free	Free	Free	Free	Free	Free
RT Channelized	-	-	None	-	-	None	-	-	None	-	-	None
Storage Length	-	-	-	-	-	-	-	-	-	-	-	-
Veh in Median Storage, #	-	0	-	-	0	-	-	0	-	-	0	-
Grade, %	-	0	-	-	0	-	-	0	-	-	0	-
Peak Hour Factor	95	95	95	95	95	95	95	95	95	95	95	95
Heavy Vehicles, %	1	4	7	3	1	1	5	5	3	1	1	1
Mvmt Flow	2	68	88	44	43	2	24	94	38	2	119	5

Major/Minor	Minor2		Minor1		Major1		Major2					
Conflicting Flow All	310	306	122	365	289	113	124	0	0	132	0	0
Stage 1	126	126	-	161	161	-	-	-	-	-	-	-
Stage 2	184	180	-	204	128	-	-	-	-	-	-	-
Critical Hdwy	7.11	6.54	6.27	7.13	6.51	6.21	4.15	-	-	4.11	-	-
Critical Hdwy Stg 1	6.11	5.54	-	6.13	5.51	-	-	-	-	-	-	-
Critical Hdwy Stg 2	6.11	5.54	-	6.13	5.51	-	-	-	-	-	-	-
Follow-up Hdwy	3.509	4.036	3.363	3.527	4.009	3.309	2.245	-	-	2.209	-	-
Pot Cap-1 Maneuver	644	604	916	589	623	943	1444	-	-	1459	-	-
Stage 1	880	788	-	839	767	-	-	-	-	-	-	-
Stage 2	820	747	-	796	792	-	-	-	-	-	-	-
Platoon blocked, %								-	-	-	-	-
Mov Cap-1 Maneuver	599	593	916	478	611	943	1444	-	-	1459	-	-
Mov Cap-2 Maneuver	599	593	-	478	611	-	-	-	-	-	-	-
Stage 1	864	787	-	824	753	-	-	-	-	-	-	-
Stage 2	757	734	-	656	791	-	-	-	-	-	-	-

Approach	EB	WB	NB	SB
HCM Control Delay, s	11.2	13	1.2	0.1
HCM LOS	B	B		

Minor Lane/Major Mvmt	NBL	NBT	NBR	EBLn1WBLn1	SBL	SBT	SBR
Capacity (veh/h)	1444	-	-	738	541	1459	-
HCM Lane V/C Ratio	0.017	-	-	0.215	0.165	0.001	-
HCM Control Delay (s)	7.5	0	-	11.2	13	7.5	0
HCM Lane LOS	A	A	-	B	B	A	A
HCM 95th %tile Q(veh)	0.1	-	-	0.8	0.6	0	-

Intersection						
Int Delay, s/veh	5.1					
Movement	EBL	EBR	NBL	NBT	SBT	SBR
Lane Configurations	T		T		T	
Traffic Vol, veh/h	130	30	36	62	87	74
Future Vol, veh/h	130	30	36	62	87	74
Conflicting Peds, #/hr	0	0	0	0	0	0
Sign Control	Stop	Stop	Free	Free	Free	Free
RT Channelized	-	None	-	None	-	None
Storage Length	0	-	-	-	-	-
Veh in Median Storage, #	0	-	-	0	0	-
Grade, %	0	-	-	0	0	-
Peak Hour Factor	92	92	92	92	92	92
Heavy Vehicles, %	3	1	10	2	1	6
Mvmt Flow	141	33	39	67	95	80

Major/Minor	Minor2	Major1		Major2	
Conflicting Flow All	280	135	175	0	0
Stage 1	135	-	-	-	-
Stage 2	145	-	-	-	-
Critical Hdwy	6.43	6.21	4.2	-	-
Critical Hdwy Stg 1	5.43	-	-	-	-
Critical Hdwy Stg 2	5.43	-	-	-	-
Follow-up Hdwy	3.527	3.309	2.29	-	-
Pot Cap-1 Maneuver	708	917	1354	-	-
Stage 1	889	-	-	-	-
Stage 2	880	-	-	-	-
Platoon blocked, %				-	-
Mov Cap-1 Maneuver	687	917	1354	-	-
Mov Cap-2 Maneuver	687	-	-	-	-
Stage 1	862	-	-	-	-
Stage 2	880	-	-	-	-

Approach	EB	NB	SB
HCM Control Delay, s	11.6	2.8	0
HCM LOS	B		

Minor Lane/Major Mvmt	NBL	NBT	EBLn1	SBT	SBR
Capacity (veh/h)	1354	-	721	-	-
HCM Lane V/C Ratio	0.029	-	0.241	-	-
HCM Control Delay (s)	7.7	0	11.6	-	-
HCM Lane LOS	A	A	B	-	-
HCM 95th %tile Q(veh)	0.1	-	0.9	-	-

Intersection						
Int Delay, s/veh	3.5					
Movement	EBT	EBR	WBL	WBT	NBL	NBR
Lane Configurations	↑	↗		↖	↖	↗
Traffic Vol, veh/h	316	112	54	151	86	100
Future Vol, veh/h	316	112	54	151	86	100
Conflicting Peds, #/hr	0	0	0	0	0	0
Sign Control	Free	Free	Free	Free	Stop	Stop
RT Channelized	-	None	-	None	-	None
Storage Length	-	200	-	-	0	125
Veh in Median Storage, #	0	-	-	0	0	-
Grade, %	0	-	-	0	0	-
Peak Hour Factor	97	97	97	97	97	97
Heavy Vehicles, %	1	1	6	2	4	3
Mvmt Flow	326	115	56	156	89	103

Major/Minor	Major1	Major2	Minor1			
Conflicting Flow All	0	0	441	0	594	326
Stage 1	-	-	-	-	326	-
Stage 2	-	-	-	-	268	-
Critical Hdwy	-	-	4.16	-	6.44	6.23
Critical Hdwy Stg 1	-	-	-	-	5.44	-
Critical Hdwy Stg 2	-	-	-	-	5.44	-
Follow-up Hdwy	-	-	2.254	-	3.536	3.327
Pot Cap-1 Maneuver	-	-	1098	-	464	713
Stage 1	-	-	-	-	727	-
Stage 2	-	-	-	-	772	-
Platoon blocked, %	-	-	-	-	-	-
Mov Cap-1 Maneuver	-	-	1098	-	438	713
Mov Cap-2 Maneuver	-	-	-	-	438	-
Stage 1	-	-	-	-	727	-
Stage 2	-	-	-	-	729	-

Approach	EB	WB	NB
HCM Control Delay, s	0	2.2	12.9
HCM LOS			B

Minor Lane/Major Mvmt	NBLn1	NBLn2	EBT	EBR	WBL	WBT
Capacity (veh/h)	438	713	-	-	1098	-
HCM Lane V/C Ratio	0.202	0.145	-	-	0.051	-
HCM Control Delay (s)	15.3	10.9	-	-	8.5	0
HCM Lane LOS	C	B	-	-	A	A
HCM 95th %tile Q(veh)	0.7	0.5	-	-	0.2	-

Lanes, Volumes, Timings
7: I-5 NB Off-Ramp/I-5 NB On-Ramp & Labree Rd

Forecast 2025 PM Peak Hour With Project
12/04/2020

Lane Group	EBL	EBT	EBR	WBL	WBT	WBR	NBL	NBT	NBR	SBL	SBT	SBR
Lane Configurations												
Traffic Volume (vph)	117	308	0	0	298	209	15	0	63	0	0	0
Future Volume (vph)	117	308	0	0	298	209	15	0	63	0	0	0
Satd. Flow (prot)	3400	3374	0	0	6052	1524	1491	1491	1302	0	0	0
Flt Permitted	0.950						0.950	0.950				
Satd. Flow (perm)	3400	3374	0	0	6052	1524	1491	1491	1302	0	0	0
Satd. Flow (RTOR)						238			72			
Lane Group Flow (vph)	133	350	0	0	339	238	8	9	72	0	0	0
Turn Type	Prot	NA			NA	Perm	Prot	NA	Prot			
Protected Phases	5	2			6		3	8	8			
Permitted Phases						6						
Total Split (s)	27.0	83.0			56.0	56.0	37.0	37.0	37.0			
Total Lost Time (s)	4.5	4.5			4.5	4.5	4.5	4.5	4.5			
Act Effct Green (s)	22.5	78.5			51.5	51.5	11.3	6.5	32.5			
Actuated g/C Ratio	0.19	0.65			0.43	0.43	0.09	0.05	0.27			
v/c Ratio	0.21	0.16			0.13	0.30	0.06	0.11	0.18			
Control Delay	34.2	7.4			20.9	3.7	43.3	35.4	8.7			
Queue Delay	0.0	0.7			0.0	0.0	0.0	0.0	0.0			
Total Delay	34.2	8.2			20.9	3.7	43.3	35.4	8.7			
LOS	C	A			C	A	D	D	A			
Approach Delay		15.3			13.8			14.5				
Approach LOS		B			B			B				
Queue Length 50th (ft)	28	36			45	0	6	~15	0			
Queue Length 95th (ft)	47	87			60	44	17	20	34			
Internal Link Dist (ft)		228			1025			631			380	
Turn Bay Length (ft)						325	325		250			
Base Capacity (vph)	637	2207			2597	789	403	81	405			
Starvation Cap Reductn	0	1507			0	0	0	0	0			
Spillback Cap Reductn	0	0			0	0	0	0	0			
Storage Cap Reductn	0	0			0	0	0	0	0			
Reduced v/c Ratio	0.21	0.50			0.13	0.30	0.02	0.11	0.18			

Intersection Summary

Cycle Length: 120
 Actuated Cycle Length: 120
 Offset: 103 (86%), Referenced to phase 2:EBT and 6:WBT, Start of Green
 Control Type: Actuated-Coordinated
 Maximum v/c Ratio: 0.30
 Intersection Signal Delay: 14.6
 Intersection LOS: B
 Intersection Capacity Utilization 32.5%
 ICU Level of Service A
 Analysis Period (min) 15
 ~ Volume exceeds capacity, queue is theoretically infinite.
 Queue shown is maximum after two cycles.

Splits and Phases: 7: I-5 NB Off-Ramp/I-5 NB On-Ramp & Labree Rd

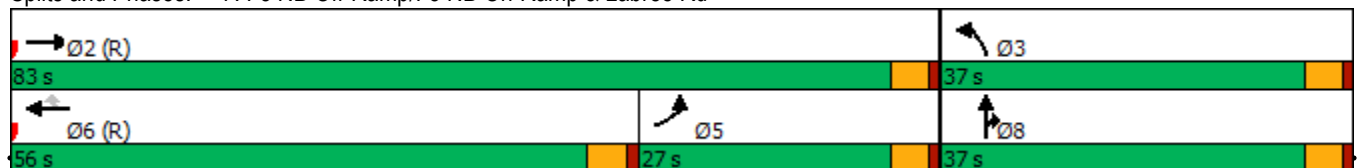

Lanes, Volumes, Timings

Synchro 10 Light Report
Page 1

Lanes, Volumes, Timings
 8: I-5 SB On-Ramp/I-5 SB Off-Ramp & Labree Rd

Forecast 2025 PM Peak Hour With Project
 12/04/2020



Lane Group	EBL	EBT	EBR	WBL	WBT	WBR	NBL	NBT	NBR	SBL	SBT	SBR
Lane Configurations		↑↑↑↑		↔↔	↑↑					↔	↔	↔
Traffic Volume (vph)	0	106	12	223	90	0	0	0	0	310	2	43
Future Volume (vph)	0	106	12	223	90	0	0	0	0	310	2	43
Satd. Flow (prot)	0	6263	0	3183	3505	0	0	0	0	1603	1609	1455
Flt Permitted				0.950						0.950	0.953	
Satd. Flow (perm)	0	6263	0	3183	3505	0	0	0	0	1603	1609	1455
Satd. Flow (RTOR)		12										55
Lane Group Flow (vph)	0	121	0	230	93	0	0	0	0	160	162	44
Turn Type		NA		Prot	NA					Prot	NA	Prot
Protected Phases		2		1	6					7	4	4
Permitted Phases												
Total Split (s)		29.0		39.0	68.0					52.0	52.0	52.0
Total Lost Time (s)		4.5		4.5	4.5					4.5	4.5	4.5
Act Effct Green (s)		24.5		34.5	63.5					47.5	47.5	47.5
Actuated g/C Ratio		0.20		0.29	0.53					0.40	0.40	0.40
v/c Ratio		0.09		0.25	0.05					0.25	0.25	0.07
Control Delay		35.1		14.4	2.6					25.7	25.7	4.7
Queue Delay		0.0		0.0	0.0					0.0	0.0	0.0
Total Delay		35.1		14.4	2.6					25.7	25.7	4.7
LOS		D		B	A					C	C	A
Approach Delay		35.1			11.0						23.2	
Approach LOS		D			B						C	
Queue Length 50th (ft)		20		71	2					86	87	0
Queue Length 95th (ft)		34		106	5					142	143	19
Internal Link Dist (ft)		635			228			826			449	
Turn Bay Length (ft)												
Base Capacity (vph)		1288		915	1854					634	636	609
Starvation Cap Reductn		0		0	0					0	0	0
Spillback Cap Reductn		0		0	0					0	0	0
Storage Cap Reductn		0		0	0					0	0	0
Reduced v/c Ratio		0.09		0.25	0.05					0.25	0.25	0.07

Intersection Summary

Cycle Length: 120
 Actuated Cycle Length: 120
 Offset: 94 (78%), Referenced to phase 2:EBT and 6:WBT, Start of Green
 Control Type: Actuated-Coordinated
 Maximum v/c Ratio: 0.25
 Intersection Signal Delay: 20.1
 Intersection LOS: C
 Intersection Capacity Utilization 32.5%
 ICU Level of Service A
 Analysis Period (min) 15

Splits and Phases: 8: I-5 SB On-Ramp/I-5 SB Off-Ramp & Labree Rd

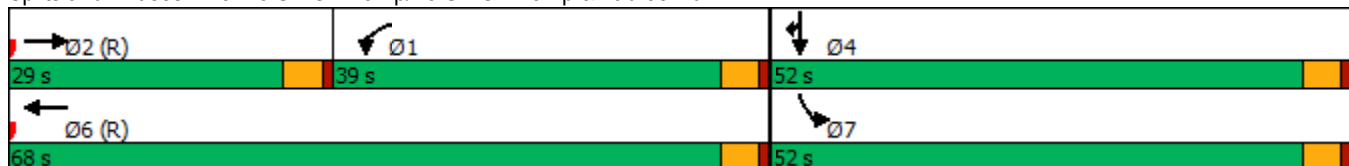

Intersection												
Int Delay, s/veh	7.9											
Movement	EBL	EBT	EBR	WBL	WBT	WBR	NBL	NBT	NBR	SBL	SBT	SBR
Lane Configurations		↻			↻					↻	↻	
Traffic Vol, veh/h	0	309	150	110	295	0	0	0	0	108	1	343
Future Vol, veh/h	0	309	150	110	295	0	0	0	0	108	1	343
Conflicting Peds, #/hr	0	0	0	0	0	0	0	0	0	0	0	0
Sign Control	Free	Free	Free	Free	Free	Free	Stop	Stop	Stop	Stop	Stop	Stop
RT Channelized	-	-	None	-	-	None	-	-	None	-	-	None
Storage Length	-	-	-	-	-	-	-	-	-	50	-	-
Veh in Median Storage, #	-	0	-	-	0	-	-	16974	-	-	0	-
Grade, %	-	0	-	-	0	-	-	0	-	-	0	-
Peak Hour Factor	92	92	92	92	92	92	92	92	92	92	92	92
Heavy Vehicles, %	1	11	22	16	13	1	2	2	2	13	1	11
Mvmt Flow	0	336	163	120	321	0	0	0	0	117	1	373

Major/Minor	Major1			Major2			Minor2			
Conflicting Flow All	-	0	0	499	0	0		979	1060	321
Stage 1	-	-	-	-	-	-		561	561	-
Stage 2	-	-	-	-	-	-		418	499	-
Critical Hdwy	-	-	-	4.26	-	-		6.53	6.51	6.31
Critical Hdwy Stg 1	-	-	-	-	-	-		5.53	5.51	-
Critical Hdwy Stg 2	-	-	-	-	-	-		5.53	5.51	-
Follow-up Hdwy	-	-	-	2.344	-	-		3.617	4.009	3.399
Pot Cap-1 Maneuver	0	-	-	997	-	0		265	225	699
Stage 1	0	-	-	-	-	0		550	512	-
Stage 2	0	-	-	-	-	0		641	545	-
Platoon blocked, %	-	-	-	-	-	-		-	-	-
Mov Cap-1 Maneuver	-	-	-	997	-	-		226	0	699
Mov Cap-2 Maneuver	-	-	-	-	-	-		226	0	-
Stage 1	-	-	-	-	-	-		550	0	-
Stage 2	-	-	-	-	-	-		547	0	-

Approach	EB	WB	SB
HCM Control Delay, s	0	2.5	20.9
HCM LOS			C

Minor Lane/Major Mvmt	EBT	EBR	WBL	WBT	SBLn1	SBLn2
Capacity (veh/h)	-	-	997	-	226	699
HCM Lane V/C Ratio	-	-	0.12	-	0.519	0.535
HCM Control Delay (s)	-	-	9.1	0	37	15.9
HCM Lane LOS	-	-	A	A	E	C
HCM 95th %tile Q(veh)	-	-	0.4	-	2.7	3.2

Intersection												
Int Delay, s/veh	8											
Movement	EBL	EBT	EBR	WBL	WBT	WBR	NBL	NBT	NBR	SBL	SBT	SBR
Lane Configurations		↔			↔		↔	↔				
Traffic Vol, veh/h	194	228	0	0	290	131	114	0	127	0	0	0
Future Vol, veh/h	194	228	0	0	290	131	114	0	127	0	0	0
Conflicting Peds, #/hr	0	0	0	0	0	0	0	0	0	0	0	0
Sign Control	Free	Free	Free	Free	Free	Free	Stop	Stop	Stop	Stop	Stop	Stop
RT Channelized	-	-	None	-	-	None	-	-	None	-	-	None
Storage Length	-	-	-	-	-	-	50	-	-	-	-	-
Veh in Median Storage, #	-	0	-	-	0	-	-	0	-	-	16965	-
Grade, %	-	0	-	-	0	-	-	0	-	-	0	-
Peak Hour Factor	98	98	98	98	98	98	98	98	98	98	98	98
Heavy Vehicles, %	16	7	1	1	7	9	28	1	10	2	2	2
Mvmt Flow	198	233	0	0	296	134	116	0	130	0	0	0

Major/Minor	Major1	Major2	Minor1
Conflicting Flow All	430	0	- - - 0 992 1059 233
Stage 1	-	-	- - - 629 629 -
Stage 2	-	-	- - - 363 430 -
Critical Hdwy	4.26	-	- - - 6.68 6.51 6.3
Critical Hdwy Stg 1	-	-	- - - 5.68 5.51 -
Critical Hdwy Stg 2	-	-	- - - 5.68 5.51 -
Follow-up Hdwy	2.344	-	- - - 3.752 4.009 3.39
Pot Cap-1 Maneuver	1059	-	0 0 - - 244 225 787
Stage 1	-	-	0 0 - - 485 477 -
Stage 2	-	-	0 0 - - 650 585 -
Platoon blocked, %	-	-	- -
Mov Cap-1 Maneuver	1059	-	- - - 192 0 787
Mov Cap-2 Maneuver	-	-	- - - 192 0 -
Stage 1	-	-	- - - 381 0 -
Stage 2	-	-	- - - 650 0 -

Approach	EB	WB	NB
HCM Control Delay, s	4.2	0	28.7
HCM LOS			D

Minor Lane/Major Mvmt	NBLn1	NBLn2	EBL	EBT	WBT	WBR
Capacity (veh/h)	192	787	1059	-	-	-
HCM Lane V/C Ratio	0.606	0.165	0.187	-	-	-
HCM Control Delay (s)	49	10.5	9.2	0	-	-
HCM Lane LOS	E	B	A	A	-	-
HCM 95th %tile Q(veh)	3.4	0.6	0.7	-	-	-

Intersection						
Int Delay, s/veh	7.7					
Movement	EBL	EBR	NBL	NBT	SBT	SBR
Lane Configurations						
Traffic Vol, veh/h	208	144	125	38	54	290
Future Vol, veh/h	208	144	125	38	54	290
Conflicting Peds, #/hr	0	0	0	0	0	0
Sign Control	Stop	Stop	Free	Free	Free	Free
RT Channelized	-	None	-	None	-	None
Storage Length	0	50	-	-	-	-
Veh in Median Storage, #	0	-	-	0	0	-
Grade, %	0	-	-	0	0	-
Peak Hour Factor	97	97	97	97	97	97
Heavy Vehicles, %	12	3	2	1	4	10
Mvmt Flow	214	148	129	39	56	299

Major/Minor	Minor2	Major1	Major2			
Conflicting Flow All	503	206	355	0	-	0
Stage 1	206	-	-	-	-	-
Stage 2	297	-	-	-	-	-
Critical Hdwy	6.52	6.23	4.12	-	-	-
Critical Hdwy Stg 1	5.52	-	-	-	-	-
Critical Hdwy Stg 2	5.52	-	-	-	-	-
Follow-up Hdwy	3.608	3.327	2.218	-	-	-
Pot Cap-1 Maneuver	511	832	1204	-	-	-
Stage 1	805	-	-	-	-	-
Stage 2	732	-	-	-	-	-
Platoon blocked, %				-	-	-
Mov Cap-1 Maneuver	455	832	1204	-	-	-
Mov Cap-2 Maneuver	455	-	-	-	-	-
Stage 1	716	-	-	-	-	-
Stage 2	732	-	-	-	-	-

Approach	EB	NB	SB
HCM Control Delay, s	15.9	6.4	0
HCM LOS	C		

Minor Lane/Major Mvmt	NBL	NBT	EBLn1	EBLn2	SBT	SBR
Capacity (veh/h)	1204	-	455	832	-	-
HCM Lane V/C Ratio	0.107	-	0.471	0.178	-	-
HCM Control Delay (s)	8.3	0	19.8	10.3	-	-
HCM Lane LOS	A	A	C	B	-	-
HCM 95th %tile Q(veh)	0.4	-	2.5	0.6	-	-

Intersection												
Int Delay, s/veh	5.8											
Movement	EBL	EBT	EBR	WBL	WBT	WBR	NBL	NBT	NBR	SBL	SBT	SBR
Lane Configurations		↕			↕			↕			↕	
Traffic Vol, veh/h	2	65	84	42	41	2	23	93	36	2	124	5
Future Vol, veh/h	2	65	84	42	41	2	23	93	36	2	124	5
Conflicting Peds, #/hr	0	0	0	0	0	0	0	0	0	0	0	0
Sign Control	Stop	Stop	Stop	Stop	Stop	Stop	Free	Free	Free	Free	Free	Free
RT Channelized	-	-	None	-	-	None	-	-	None	-	-	None
Storage Length	-	-	-	-	-	-	-	-	-	-	-	-
Veh in Median Storage, #	-	0	-	-	0	-	-	0	-	-	0	-
Grade, %	-	0	-	-	0	-	-	0	-	-	0	-
Peak Hour Factor	95	95	95	95	95	95	95	95	95	95	95	95
Heavy Vehicles, %	1	4	7	3	1	1	5	5	3	1	1	1
Mvmt Flow	2	68	88	44	43	2	24	98	38	2	131	5

Major/Minor	Minor2		Minor1		Major1		Major2					
Conflicting Flow All	326	322	134	381	305	117	136	0	0	136	0	0
Stage 1	138	138	-	165	165	-	-	-	-	-	-	-
Stage 2	188	184	-	216	140	-	-	-	-	-	-	-
Critical Hdwy	7.11	6.54	6.27	7.13	6.51	6.21	4.15	-	-	4.11	-	-
Critical Hdwy Stg 1	6.11	5.54	-	6.13	5.51	-	-	-	-	-	-	-
Critical Hdwy Stg 2	6.11	5.54	-	6.13	5.51	-	-	-	-	-	-	-
Follow-up Hdwy	3.509	4.036	3.363	3.527	4.009	3.309	2.245	-	-	2.209	-	-
Pot Cap-1 Maneuver	629	592	902	575	610	938	1430	-	-	1454	-	-
Stage 1	868	779	-	835	764	-	-	-	-	-	-	-
Stage 2	816	744	-	784	783	-	-	-	-	-	-	-
Platoon blocked, %								-	-	-	-	-
Mov Cap-1 Maneuver	584	581	902	465	598	938	1430	-	-	1454	-	-
Mov Cap-2 Maneuver	584	581	-	465	598	-	-	-	-	-	-	-
Stage 1	852	778	-	820	750	-	-	-	-	-	-	-
Stage 2	754	731	-	644	782	-	-	-	-	-	-	-

Approach	EB		WB		NB		SB	
HCM Control Delay, s	11.4		13.2		1.1		0.1	
HCM LOS	B		B					

Minor Lane/Major Mvmt	NBL	NBT	NBR	EBLn1	WBLn1	SBL	SBT	SBR
Capacity (veh/h)	1430	-	-	724	528	1454	-	-
HCM Lane V/C Ratio	0.017	-	-	0.22	0.169	0.001	-	-
HCM Control Delay (s)	7.6	0	-	11.4	13.2	7.5	0	-
HCM Lane LOS	A	A	-	B	B	A	A	-
HCM 95th %tile Q(veh)	0.1	-	-	0.8	0.6	0	-	-

Intersection						
Int Delay, s/veh	5					
Movement	EBL	EBR	NBL	NBT	SBT	SBR
Lane Configurations						
Traffic Vol, veh/h	146	30	36	66	98	114
Future Vol, veh/h	146	30	36	66	98	114
Conflicting Peds, #/hr	0	0	0	0	0	0
Sign Control	Stop	Stop	Free	Free	Free	Free
RT Channelized	-	None	-	None	-	None
Storage Length	0	-	-	-	-	-
Veh in Median Storage, #	0	-	-	0	0	-
Grade, %	0	-	-	0	0	-
Peak Hour Factor	92	92	92	92	92	92
Heavy Vehicles, %	3	1	10	2	1	6
Mvmt Flow	159	33	39	72	107	124

Major/Minor	Minor2	Major1		Major2	
Conflicting Flow All	319	169	231	0	0
Stage 1	169	-	-	-	-
Stage 2	150	-	-	-	-
Critical Hdwy	6.43	6.21	4.2	-	-
Critical Hdwy Stg 1	5.43	-	-	-	-
Critical Hdwy Stg 2	5.43	-	-	-	-
Follow-up Hdwy	3.527	3.309	2.29	-	-
Pot Cap-1 Maneuver	672	878	1291	-	-
Stage 1	858	-	-	-	-
Stage 2	875	-	-	-	-
Platoon blocked, %				-	-
Mov Cap-1 Maneuver	651	878	1291	-	-
Mov Cap-2 Maneuver	651	-	-	-	-
Stage 1	831	-	-	-	-
Stage 2	875	-	-	-	-

Approach	EB	NB	SB
HCM Control Delay, s	12.3	2.8	0
HCM LOS	B		

Minor Lane/Major Mvmt	NBL	NBT	EBLn1	SBT	SBR
Capacity (veh/h)	1291	-	681	-	-
HCM Lane V/C Ratio	0.03	-	0.281	-	-
HCM Control Delay (s)	7.9	0	12.3	-	-
HCM Lane LOS	A	A	B	-	-
HCM 95th %tile Q(veh)	0.1	-	1.1	-	-

Intersection						
Int Delay, s/veh	4.3					
Movement	EBT	EBR	WBL	WBT	NBL	NBR
Lane Configurations	↑	↑		↑	↑	↑
Traffic Vol, veh/h	321	112	105	165	86	120
Future Vol, veh/h	321	112	105	165	86	120
Conflicting Peds, #/hr	0	0	0	0	0	0
Sign Control	Free	Free	Free	Free	Stop	Stop
RT Channelized	-	None	-	None	-	None
Storage Length	-	200	-	-	0	125
Veh in Median Storage, #	0	-	-	0	0	-
Grade, %	0	-	-	0	0	-
Peak Hour Factor	97	97	97	97	97	97
Heavy Vehicles, %	1	1	10	2	4	10
Mvmt Flow	331	115	108	170	89	124

Major/Minor	Major1	Major2	Minor1		
Conflicting Flow All	0	0	446	0	717
Stage 1	-	-	-	-	331
Stage 2	-	-	-	-	386
Critical Hdwy	-	-	4.2	-	6.44
Critical Hdwy Stg 1	-	-	-	-	5.44
Critical Hdwy Stg 2	-	-	-	-	5.44
Follow-up Hdwy	-	-	2.29	-	3.536
Pot Cap-1 Maneuver	-	-	1073	-	393
Stage 1	-	-	-	-	723
Stage 2	-	-	-	-	683
Platoon blocked, %	-	-	-	-	-
Mov Cap-1 Maneuver	-	-	1073	-	349
Mov Cap-2 Maneuver	-	-	-	-	349
Stage 1	-	-	-	-	723
Stage 2	-	-	-	-	607

Approach	EB	WB	NB
HCM Control Delay, s	0	3.4	14.4
HCM LOS			B

Minor Lane/Major Mvmt	NBLn1	NBLn2	EBT	EBR	WBL	WBT
Capacity (veh/h)	349	693	-	-	1073	-
HCM Lane V/C Ratio	0.254	0.179	-	-	0.101	-
HCM Control Delay (s)	18.8	11.3	-	-	8.7	0
HCM Lane LOS	C	B	-	-	A	A
HCM 95th %tile Q(veh)	1	0.6	-	-	0.3	-

Intersection						
Int Delay, s/veh	1.6					
Movement	EBT	EBR	WBL	WBT	NBL	NBR
Lane Configurations	↔			↔	↔	
Traffic Vol, veh/h	416	25	3	205	65	7
Future Vol, veh/h	416	25	3	205	65	7
Conflicting Peds, #/hr	0	0	0	0	0	0
Sign Control	Free	Free	Free	Free	Stop	Stop
RT Channelized	-	None	-	None	-	None
Storage Length	-	-	-	-	0	-
Veh in Median Storage, #	0	-	-	0	0	-
Grade, %	0	-	-	0	0	-
Peak Hour Factor	92	92	92	92	92	92
Heavy Vehicles, %	1	10	10	3	10	10
Mvmt Flow	452	27	3	223	71	8

Major/Minor	Major1	Major2	Minor1		
Conflicting Flow All	0	0	479	0	695
Stage 1	-	-	-	-	466
Stage 2	-	-	-	-	229
Critical Hdwy	-	-	4.2	-	6.5
Critical Hdwy Stg 1	-	-	-	-	5.5
Critical Hdwy Stg 2	-	-	-	-	5.5
Follow-up Hdwy	-	-	2.29	-	3.59
Pot Cap-1 Maneuver	-	-	1043	-	396
Stage 1	-	-	-	-	615
Stage 2	-	-	-	-	791
Platoon blocked, %	-	-	-	-	-
Mov Cap-1 Maneuver	-	-	1043	-	395
Mov Cap-2 Maneuver	-	-	-	-	395
Stage 1	-	-	-	-	615
Stage 2	-	-	-	-	789

Approach	EB	WB	NB
HCM Control Delay, s	0	0.1	15.9
HCM LOS			C

Minor Lane/Major Mvmt	NBLn1	EBT	EBR	WBL	WBT
Capacity (veh/h)	408	-	-	1043	-
HCM Lane V/C Ratio	0.192	-	-	0.003	-
HCM Control Delay (s)	15.9	-	-	8.5	0
HCM Lane LOS	C	-	-	A	A
HCM 95th %tile Q(veh)	0.7	-	-	0	-

Intersection						
Int Delay, s/veh	4.1					
Movement	EBL	EBR	SET	SER	NWL	NWT
Lane Configurations						
Traffic Vol, veh/h	58	66	75	53	115	243
Future Vol, veh/h	58	66	75	53	115	243
Conflicting Peds, #/hr	0	0	0	0	0	0
Sign Control	Stop	Stop	Free	Free	Free	Free
RT Channelized	-	None	-	None	-	None
Storage Length	125	0	-	-	-	-
Veh in Median Storage, #	0	-	0	-	-	0
Grade, %	0	-	0	-	-	0
Peak Hour Factor	86	86	86	86	86	86
Heavy Vehicles, %	2	20	9	2	5	4
Mvmt Flow	67	77	87	62	134	283

Major/Minor	Minor1	Major1	Major2		
Conflicting Flow All	669	118	0	0	149
Stage 1	118	-	-	-	-
Stage 2	551	-	-	-	-
Critical Hdwy	6.42	6.4	-	-	4.15
Critical Hdwy Stg 1	5.42	-	-	-	-
Critical Hdwy Stg 2	5.42	-	-	-	-
Follow-up Hdwy	3.518	3.48	-	-	2.245
Pot Cap-1 Maneuver	423	887	-	-	1414
Stage 1	907	-	-	-	-
Stage 2	577	-	-	-	-
Platoon blocked, %			-	-	-
Mov Cap-1 Maneuver	376	887	-	-	1414
Mov Cap-2 Maneuver	376	-	-	-	-
Stage 1	907	-	-	-	-
Stage 2	512	-	-	-	-

Approach	EB	SE	NW
HCM Control Delay, s	12.8	0	2.5
HCM LOS	B		

Minor Lane/Major Mvmt	NWL	NWT	EBLn1	EBLn2	SET	SER
Capacity (veh/h)	1414	-	376	887	-	-
HCM Lane V/C Ratio	0.095	-	0.179	0.087	-	-
HCM Control Delay (s)	7.8	0	16.7	9.4	-	-
HCM Lane LOS	A	A	C	A	-	-
HCM 95th %tile Q(veh)	0.3	-	0.6	0.3	-	-

JACKSON HIGHWAY WAREHOUSE
TRAFFIC IMPACT ANALYSIS

LEFT TURN WARRANT CALCULATION SHEET

APPENDIX

Exhibit 1310-7a Left-Turn Storage Guidelines: Two-Lane, Unsignalized

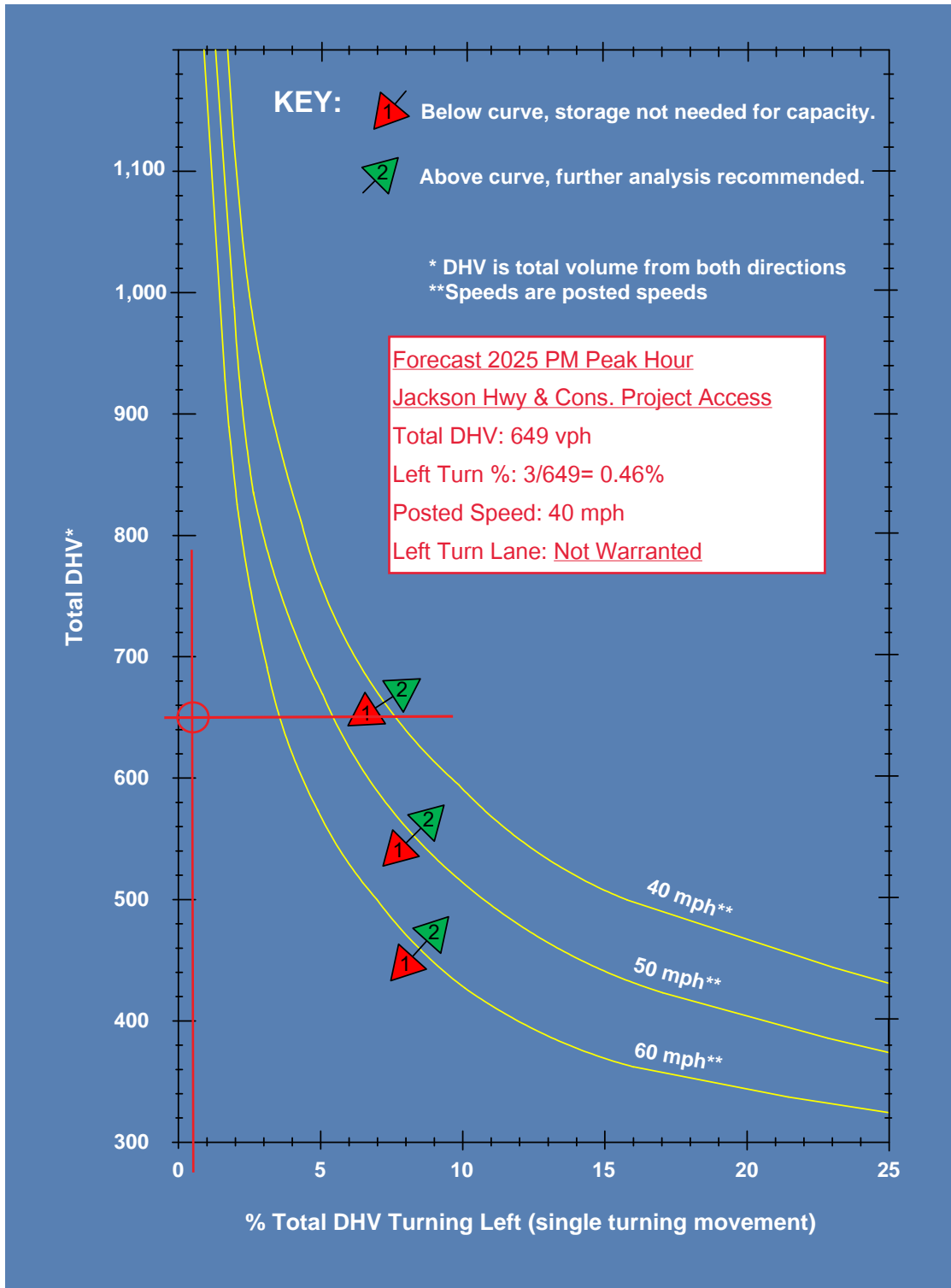
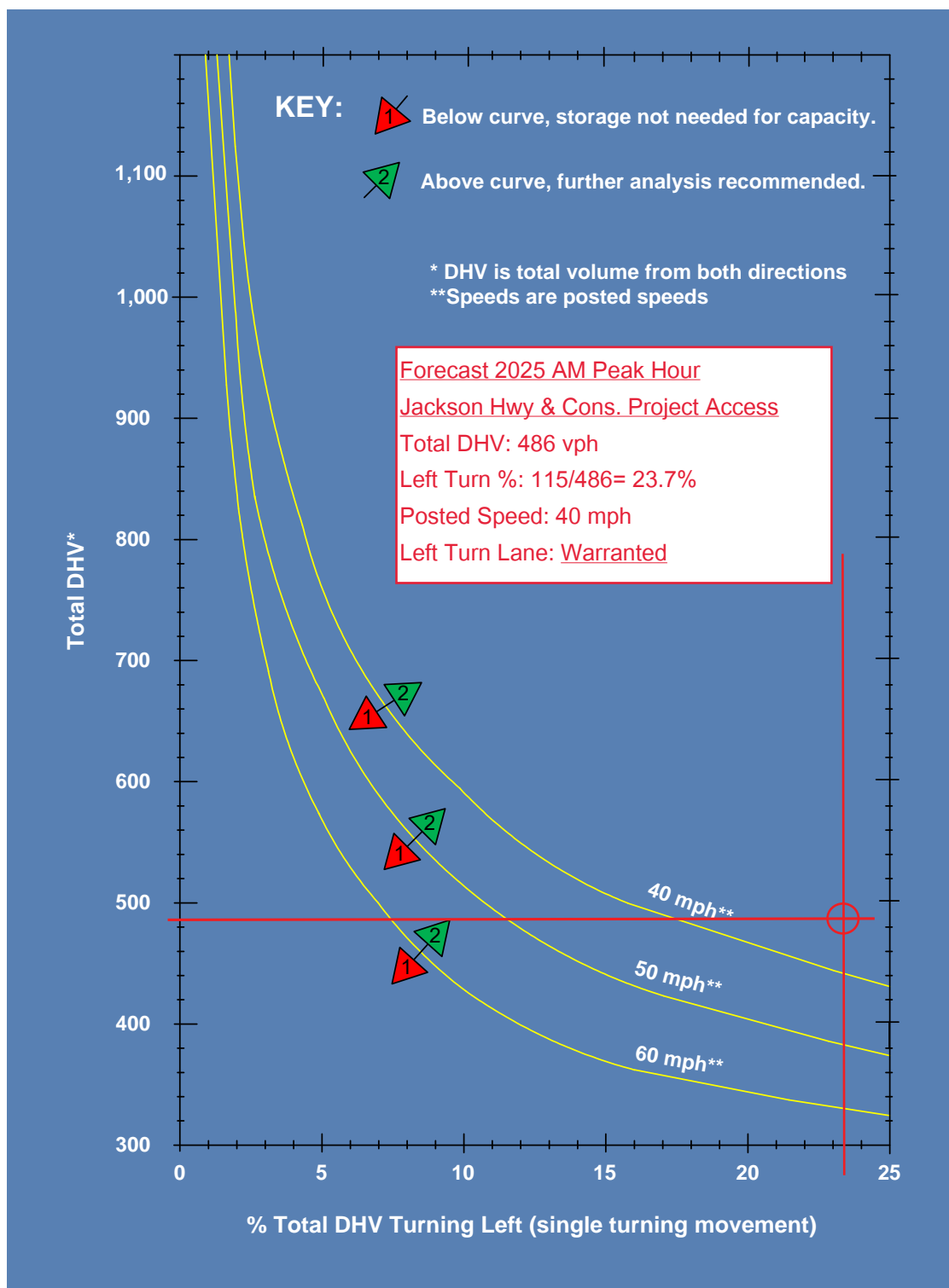

Exhibit 1310-7a Left-Turn Storage Guidelines: Two-Lane, Unsignalized



JACKSON HIGHWAY WAREHOUSE
TRAFFIC IMPACT ANALYSIS

RIGHT TURN WARRANT CALCULATION SHEET

APPENDIX

Exhibit 1310-11 Right-Turn Lane Guidelines

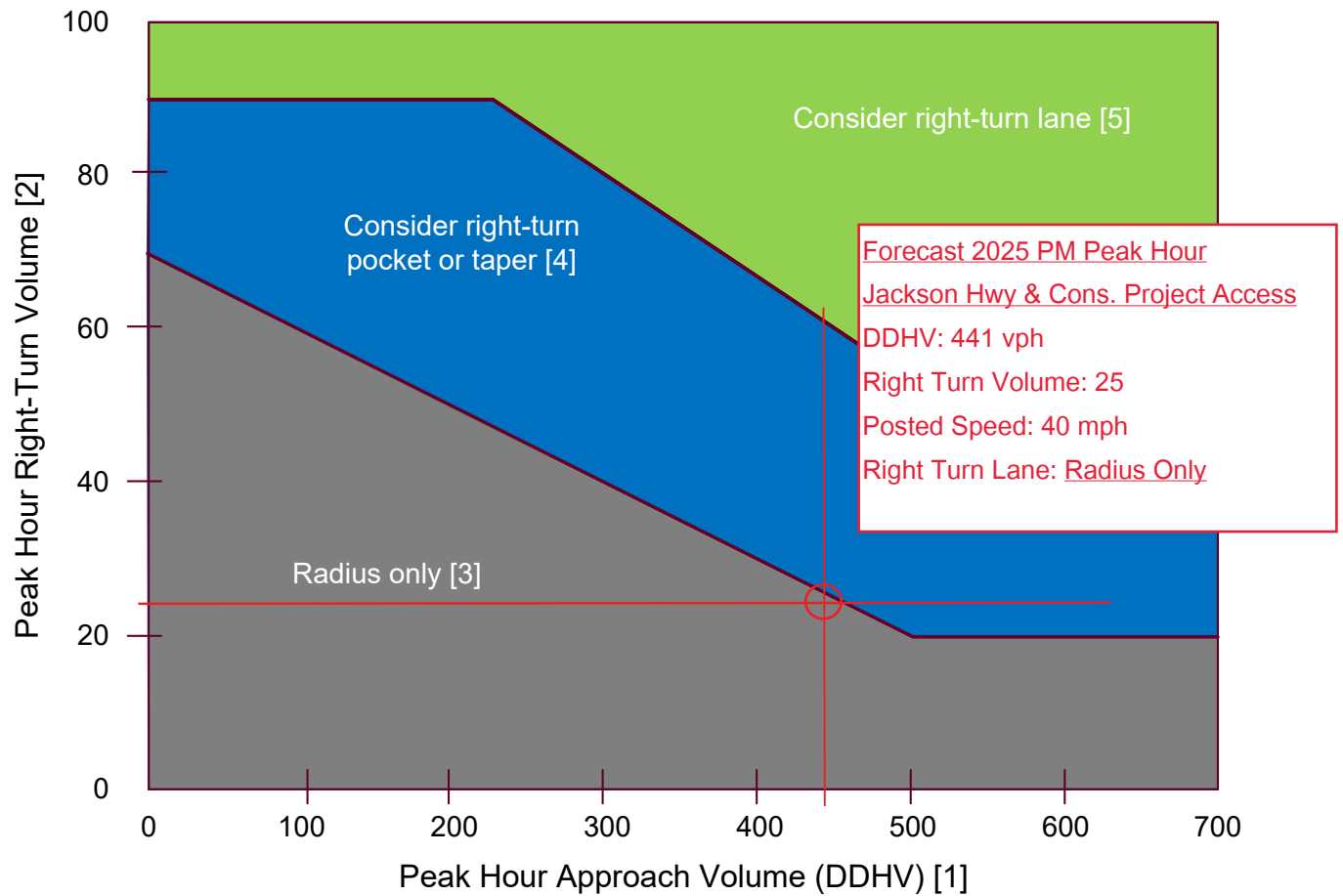

Notes:

- [1] For two-lane highways, use the peak hour DDHV (through + right-turn).
 For multilane, highways (posted speed 45 mph or above), use the right-lane peak hour approach volume (through + right-turn).
- [2] When all three of the following conditions are met, reduce the right-turn DDHV by 20:
 - The posted speed is 45 mph or below
 - The right-turn volume is greater than 40 VPH
 - The peak hour approach volume (DDHV) is less than 300 VPH
- [3] For right-turn corner design, see Exhibit 1310-6.
- [4] For right-turn pocket or taper design, see Exhibit 1310-12.
- [5] For right-turn lane design, see Exhibit 1310-13.